

# 14 Buffet & accessories

Buffet y accesorios

Buffet et accessoires



<b>14.1</b>	<b>BUFFET TROLLEYS</b>	438
	<i>CARROS BUFFET / CHARRIOT BUFFET</i>	
<b>14.2</b>	<b>DISPLAY STANDS &amp; BASKETS</b>	444
	<i>PRESENTACIÓN Y EXPOSITORES</i>	
	<i>PRÉSENTOIRS ET PRÉSENTOIRS CORBEILLES</i>	
<b>14.3</b>	<b>BUFFET COOKWARE</b>	458
	<i>BATERIAS PARA BUFFET / BUFFET CUISINE</i>	
	<b>Cool line collection</b>	458
	<b>Bronze collection</b>	462
	<b>Miramar® collection</b>	464
<b>14.4</b>	<b>SUPER SHAPES</b>	470
	<b>BUFFET PRESENTATION STEAM TABLE PANS</b>	
	<i>CUBETAS PRESENTACIÓN BUFFET / BACS PRÉSENTATION BUFFET</i>	
<b>14.5</b>	<b>CUBIC</b>	472
<b>14.6</b>	<b>CHAFERS &amp; DISPENSERS</b>	488
	<i>CHAFINGS Y DISPENSADORES / CHAFERS ET DISTRIBUTEURS</i>	
<b>14.7</b>	<b>PROTECTION &amp; COVERS</b>	498
	<i>PROTECCIÓN Y TAPAS / PROTECTION ET COUVERCLES</i>	
<b>14.8</b>	<b>BOWLS &amp; SERVING TRAYS</b>	500
	<i>BOLS &amp; BANDEJAS DE SERVICIO / BOLS &amp; PLATEAUX</i>	
<b>14.9</b>	<b>SERVING TOOLS</b>	503
	<i>UTENSILIOS DE SERVICIO / USTENSILES DE SERVICE BUFFET</i>	
<b>14.10</b>	<b>SIGNS</b>	512
	<i>SEÑALIZACIÓN / SIGNALIZATION</i>	

# BUFFET TROLLEYS

Design your own space



# 14.1 BUFFET TROLLEYS

by **pujadas**

Wo  
Wood

CS  
Carbon steel

Easy to assemble thanks to a tool-free anchoring system

Fácil de montar gracias a su sistema de anclaje sin herramientas

Facile à monter grâce à un système d'ancrage sans outils

Handle included with all carts. A second one can be added.

Tirador incluido en todos los carros. Se puede añadir otro.

Poignée incluse avec tous les chariots. Une deuxième peut être ajoutée.

Revolving casters, 2 with brakes

Ruedas giratorias, 2 con freno

Roues pivotantes, 2 avec frein

Multiple shelves and compartments compatible with GN sizes

Múltiples estantes y espacios compatibles con medidas GN

Multiplés étagères et espaces compatibles avec les dimensions GN

Central shelves designed for flat or inclined display

Estantes centrales diseñados para presentación en plano o inclinados

Étagères centrales conçues pour une présentation à plat ou inclinée

Premium materials and high-quality finishes:

- Tubular structure in black matte-finished carbon steel.
- Solid wood tabletop with a Formica coating resistant to heat, humidity, and wear.

Materiales premium y acabados de alta calidad:

- Estructura tubular de acero al carbono acabado negro mate.
- Tablero de madera maciza con recubrimiento de fórmica resistente al calor, la humedad y el desgaste.

Matériaux haut de gamme et des finitions de haute qualité :

- Structure tubulaire en acier au carbone avec finition noire mate.
- Plateau en bois massif avec revêtement en Formica résistant à la chaleur, à l'humidité et à l'usure.

NEW

Two-height adjustable panel  
Panel ajustable a dos alturas  
Panneau réglable à deux hauteurs

Bottle holder integrated into the handle  
Botellero integrado en el tirador  
Porte-bouteilles intégré à la poignée

**Versatile, with multiple work and storage areas. Adaptable to any type of space or event.**

Versátil, con múltiples espacios de trabajo y almacenaje. Adaptable a cualquier tipo de espacio o evento.

Polyvalent, avec multiples zones de travail et de rangement, Adaptable à tout type d'espace ou d'événement.

NEW

**Buffet trolley with top module**  
Carro buffet con módulo superior  
Chariot buffet avec module supérieur

**Buffet trolley**  
Carro buffet  
Chariot buffet



2 wire baskets GN 1/1 included.  
2 cestas metálicas GN 1/1 incluidas.  
2 paniers métalliques GN 1/1 inclus.

REF	W x D x H cm	🛒/📦	€/u
P90950	124 x 50 x 88	1/1	2.950,00



2 wire baskets GN 1/1 & 3 wooden boxes GN 1/2 included.  
2 cestas metálicas GN 1/1 y 3 cajas de madera GN 1/2 incluidas.  
2 paniers métalliques GN 1/1 et 3 caisses en bois GN 1/2 inclus.

REF	W x D x H cm	🛒/📦	€/u
P90940	124 x 50 x 150	1/1	3.800,00

**DESIGN YOUR OWN SPACE** / Diseña tu propio espacio / Concevez votre propre espace

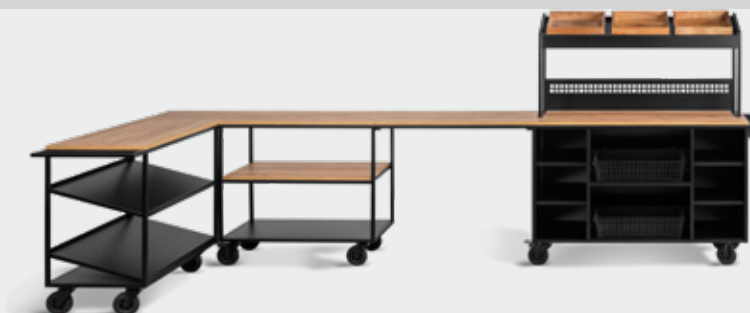

# 14.1 Buffet trolleys

Carros buffet / Chariot buffet

NEW



**Two-level serving trolley wooden top**  
 Carro de servicio dos niveles encimera madera  
 Chariot service à deux niveaux plateau en bois



REF	W x D x H cm		€/u
P90960	90 x 50 x 88	1/1	1.495,00

**Three-level serving trolley wooden top**  
 Carro de servicio tres niveles encimera madera  
 Chariot service à trois niveaux plateau en bois



REF	W x D x H cm		€/u
P90961	90 x 50 x 88	1/1	1.660,00

**Three-level serving trolley wooden top**  
 Carro de servicio tres niveles encimera madera  
 Chariot service à trois niveaux plateau en bois



REF	W x D x H cm		€/u
P90962	90 x 50 x 88	1/1	1.560,00

**Three-level serving trolley wooden top**  
 Carro de servicio tres niveles encimera madera  
 Chariot service à trois niveaux plateau en bois



**Inclined middle shelf / Estante central inclinado / Étagère centrale inclinée.**

REF	W x D x H cm		€/u
P90963	90 x 50 x 88	1/1	1.595,00



NEW

**Three-level serving trolley wooden top**  
 Carro de servicio tres niveles encimera madera  
 Chariot service à trois niveaux plateau en bois



**2 inclined shelves**  
 2 estantes inclinados  
 2 étagères inclinées

REF	W x D x H cm		€/u
P90964	90 x 50 x 88	1/1	1.610,00

**Shelf**  
 Estante  
 Étagère



REF	W x D x H cm		€/u
P90980	90 x 50 x 4	1/1	349,00

**Handle**  
 Tirador  
 Poignée



REF	W x D x H cm		€/u
P90971	50 x 13 x 2	1/1	120,00

# Buffet trolleys 14.1

Carros buffet / Chariot buffet

See products on  
 Ver productos en / Voir produits en page

P. 446

**Wooden box GN 1/1 and 1/2**  
 Caja de madera GN 1/1 y 1/2  
 Caisse en bois GN 1/1 et 1/2



**Corner shelf**  
 Estante esquinero  
 Étagère d'angle



**Maximum load 20 kg**  
 Carga máxima 20 kg  
 Charge maximale 20 kg

REF	W x D x H cm		€/u
P90981	50 x 50 x 4	1/1	295,00

**Bottle rack**  
 Botellero  
 Porte-bouteilles



**Inserts into the handle**  
 Se inserta en el tirador  
 S'insère dans la poignée

REF	W x D x H cm		€/u
P90970	48 x 10,5 x 10	1/1	79,00

## 14.2 Display stands & baskets

Presentación y expositores / Présentoirs et présentoirs corbeilles

### Nova

#### Induction warming station

Estación inducción mantenedora

Station induction maintien de température

NEW



Induction unit, temperature control knob and wooden frame included.  
Incluye placa de inducción, mando control de temperatura y marco de madera.  
Comprend une plaque à induction, un contrôleur de température et un cadre en bois.

REF	V	W	Hz	☎	🛒/📦	€/u
P595026	220-240	1000	50/60	EU	1/1	299,00

#### Serving tray

Bandeja de servicio

Plateau service

NEW



Reversible  
Réversible

Suitable for: / Compatibles con: / Adaptable pour: P595050

REF	W x D x H cm	🛒/📦	€/u
P595024	62 x 42 x 7	1/1	49,95

#### Tray stand

Soporte para bandeja

Support plateau

NEW



Suitable for:  
Compatibles con:  
Adaptable pour:  
P595024

REF	W x D x H cm	🛒/📦	€/u
P595050	42 x 36 x 81,5	1/1	79,95

## Display stands & baskets 14.2

Presentación y expositores / Présentoirs et présentoirs corbeilles



### Nova



#### Large wooden box

Caja grande de madera

Grande boîte en bois

Stackable  
Apilable  
Empilable

REF	W x D x H cm	🛒/📦	€/u
P595006	17,5 x 31 x 12,5	1/1	20,35

#### Small wooden box

Caja pequeña de madera

Petite boîte en bois

Stackable  
Apilable  
Empilable



REF	W x D x H cm	🛒/📦	€/u
P595005	17,5 x 17 x 12,5	1/1	17,25

#### Large double wooden box

Caja grande doble de madera

Grande boîte double en bois

Stackable  
Apilable  
Empilable



REF	W x D x H cm	🛒/📦	€/u
P595007	35 x 31 x 12,5	1/1	36,60

# 14.2 Display stands & baskets

Presentación y expositores / Présentoirs et présentoirs corbeilles



NEW

**Flat display stand GN**  
Expositor metálico recto GN  
Présentoir métallique droit GN

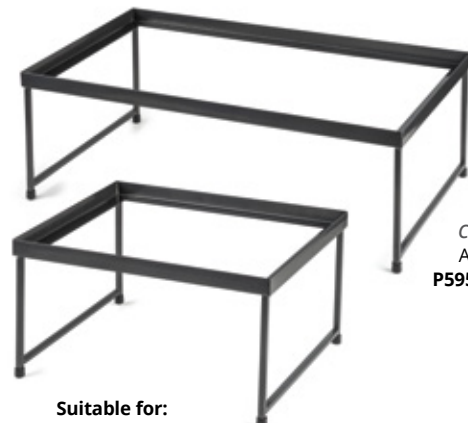

Suitable for:  
Compatibles con:  
Adaptable pour:  
P595015, P595016.

REF	W x D x H cm	GN	Shopping icon	€ / u
P598004	55,5 x 35 x 20	1/1	1/1	33,95
P598005	34,5 x 29 x 20	1/2	1/1	29,95

**Angled display stand GN**  
Expositor metálico inclinado GN  
Présentoir métallique incliné GN



Suitable for:  
Compatibles con:  
Adaptable pour:  
P595015, P595016.

REF	W x D x H cm	GN	Shopping icon	€ / u
P598006	55,5 x 35 x 15	1/1	1/1	36,95
P598007	34,5 x 29 x 15	1/2	1/1	32,95

**Wooden box GN 1/1**  
Caja de madera GN 1/1  
Caisse en bois GN 1/1



Stackable  
Apilable  
Empilable



Suitable for display boards and pans GN 1/1.  
Compatibles con soportes de presentación y cubetas GN 1/1.  
Adaptable pour présentoirs and bacs GN 1/1.

REF	W x D x H cm	Shopping icon	€ / u
P595013	54,5 x 34 x 6	1/1	35,65
P595014	54,5 x 34 x 9	1/1	45,85

**Wooden box GN 1/2**  
Caja de madera GN 1/2  
Caisse en bois GN 1/2



Stackable  
Apilable  
Empilable



Suitable for display boards and pans GN 1/2.  
Compatibles con soportes de presentación y cubetas GN 1/2.  
Adaptable pour présentoirs and bacs GN 1/2.

REF	W x D x H cm	Shopping icon	€ / u
P595015	34 x 28 x 6	1/1	26,45
P595016	34 x 28 x 9	1/1	33,60

# Display stands & baskets 14.2

Presentación y expositores / Présentoirs et présentoirs corbeilles

**Wooden box GN 1/3**  
Caja de madera GN 1/3  
Caisse en bois GN 1/3

NEW



Stackable  
Apilable  
Empilable



Suitable for display boards and pans GN 1/3.  
Compatibles con soportes de presentación y cubetas GN 1/3.  
Adaptable pour présentoirs and bacs GN 1/3.

REF	W x D x H cm	Shopping icon	€ / u
P595021	34 x 19 x 6	1/1	19,95

**Wooden box GN 2/4**  
Caja de madera GN 2/4  
Caisse en bois GN 2/4

NEW



Stackable  
Apilable  
Empilable



Suitable for display boards and pans GN 2/4.  
Compatibles con soportes de presentación y cubetas GN 12/4.  
Adaptable pour présentoirs and bacs GN 1/4.

REF	W x D x H cm	Shopping icon	€ / u
P595020	54,5 x 18 x 6	1/1	25,95

**Display board**  
Soporte presentación  
Présentoir



1/1 2/4



REF	GN	W x D x H cm	Shopping icon	€ / u
P22680	1/1	53 x 32,5 x 2	1/3	45,85
P22681	1/2	32,5 x 26,5 x 2	1/3	24,45
P22682	1/3	32,5 x 17,6 x 2	1/3	17,30
P22683	2/4	53 x 16,2 x 2	1/6	25,45

Suitable for  
Compatible con / Adaptable pour

P. 429



P. 461



P. 425



P. 426



## 14.2 Display stands & baskets

Presentación y expositores / Présentoirs et présentoirs corbeilles



### Nova



dishwasher

**Cutlery-holder tray**  
Bandeja porta-cubiertos  
Plateau porte-couverts



**4 Compartments**  
4 Compartimentos  
4 Compartiments

**With non-slip feet**  
Con pies antideslizantes  
Avec pieds antidérapants

REF	W x D x H cm		€ / u
P595009	54 x 33,5 x 9,5	1/1	49,95

**Cutlery-holder box**  
Caja para cubiertos  
Caisse porte-couverts



NEW

**Stackable**  
Apilable  
Empilable

REF	W x D x H cm		€ / u
P595022	28 x 15 x 7	1/1	17,95

**Cutting board**  
Tabla de cortar  
Planche à découper



**With non-slip feet**  
Con pies antideslizantes  
Avec pieds antidérapants

REF	W x D x H cm		€ / u
P595008	48 x 32 x 2	1/1	30,55

**Serving tray**  
Bandeja de servicio  
Plateau service



**Stackable**  
Apilable  
Empilable

REF	W x D x H cm		€ / u
P595012	45 x 35 x 6	1/1	34,65

## Display stands & baskets 14.2

Presentación y expositores / Présentoirs et présentoirs corbeilles



dishwasher

### Nova



**Wooden shelf**  
Estante de madera  
Tablette en bois



REF	W x D x H cm		€ / u
P595010	100 x 25 x 2,5	1/1	48,90
P595011	70 x 25 x 2,5	1/1	35,65

**Wooden bowl**  
Bol de madera  
Bol en bois



REF	Ø cm	H cm		€ / u
P595017	30	12,5	1/5	30,55

**Wooden bowl**  
Bol de madera  
Bol en bois



REF	W x D x H cm		€ / u
P595019	30 x 30 x 12	1/4	30,55

**Suitable for**  
Compatible con / Adaptable pour

P. 456

**Buffet stand**  
Soporte para buffet  
Présentoir buffet

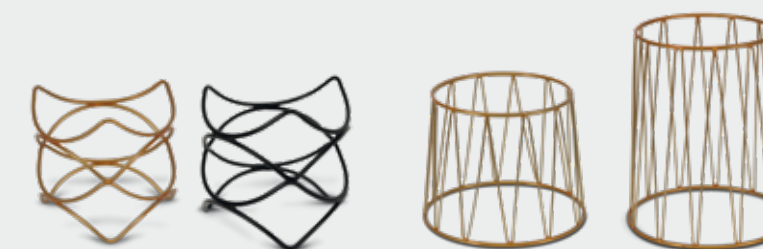

# 14.2 Display stands & baskets

Presentación y expositores / Présentoirs et présentoirs corbeilles



## One tier flat display stand

Expositor metálico recto de un nivel  
Présentoir métallique droit à un niveau



Baskets not included  
Cestas no incluidas  
Panniers non inclus



REF	W x D x H cm	Shopping icon	€ / u
P598001	45 x 30 x 20,5	1/8	34,55

## One tier angled display stand

Expositor metálico inclinado de un nivel  
Présentoir métallique incliné à un niveau



Baskets not included  
Cestas no incluidas  
Panniers non inclus



REF	W x D x H cm	Shopping icon	€ / u
P598002	45 x 30 x 14,5	1/8	38,85

## Three tier flat display stand

Expositor metálico recto de 3 niveles  
Présentoir métallique droit 3 niveaux



Baskets not included  
Cestas no incluidas  
Panniers non inclus



REF	W x D x H cm	Shopping icon	€ / u
P598003	30 x 24 x 51,5	1/2	60,75

# Display stands & baskets 14.2

Presentación y expositores / Présentoirs et présentoirs corbeilles

## Rectangular metal wire basket

Cesta metálica rectangular  
Panier métallique rectangulaire



Suitable for  
Combinable con  
Adaptable pour  
P598001 / P598002

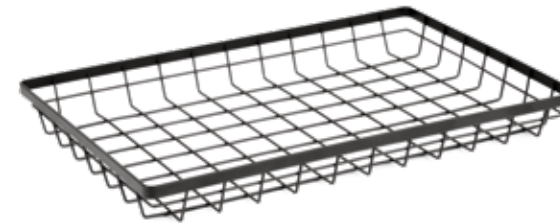

REF	W x D x H cm	Shopping icon	€ / u
P591006	45 x 30 x 5	1/12	19,85

## Rectangular metal wire basket

Cesta metálica rectangular  
Panier métallique rectangulaire



Suitable for  
Combinable con  
Adaptable pour  
P598003



REF	W x D x H cm	Shopping icon	€ / u
P591007	30 x 22,5 x 5	1/12	16,35

## Wooden box

Caja de madera  
Caisse en bois



dishwasher

Suitable for  
Combinable con  
Adaptable pour  
P598001 / P598002

Stackable  
Apilables  
Empilables



REF	W x D x H cm	Shopping icon	€ / u
P595001	45 x 30 x 5	1/6	31,45
P595002	45 x 30 x 10	1/4	40,55

## Wooden box

Caja de madera  
Caisse en bois



dishwasher

Suitable for  
Combinable con  
Adaptable pour  
P598003

Stackable  
Apilables  
Empilables



REF	W x D x H cm	Shopping icon	€ / u
P595003	30 x 22,5 x 5	1/12	29,80
P595004	30 x 22,5 x 10	1/8	33,15

# 14.2 Display stands & baskets

Presentación y expositores / Présentoirs et présentoirs corbeilles



**Black GN wire basket**  
Cesta rejilla GN negra  
Pannier metalique GN noir

**Black GN wire basket**  
Cesta rejilla GN negra  
Pannier metalique GN noir



1/1

REF	Mod	W x D x H cm	🛒/📦	€/u
P596110	1/1	52 x 31,5 x 12	1/6	40,90
P596111	1/1	52 x 31,5 x 16	1/6	50,85



1/2

REF	Mod	W x D x H cm	🛒/📦	€/u
P596120	1/2	31,5 x 25,5 x 12	1/6	28,75
P596121	1/2	31,5 x 25,5 x 16	1/6	38,40

**Black GN wire basket**  
Cesta rejilla GN negra  
Pannier metalique GN noir



1/3

REF	Mod	W x D x H cm	🛒/📦	€/u
P596130	1/3	31,5 x 17 x 12	1/6	25,70
P596131	1/3	31,5 x 17 x 16	1/6	31,50

Suitable for  
Compatible con / Adaptable pour



P. 426



P. 427



P. 425



P. 453



dishwasher

NATURAL  
FIBERS

# Display stands & baskets 14.2

Presentación y expositores / Présentoirs et présentoirs corbeilles



Dos posiciones: derecho y revés.  
**Two positions: right and reverse.**  
Deux positions: droit et envers  
Zwei Positionen: rechts und rückwärts.

**GN buffet bamboo box**  
Caja GN bambú buffet  
Présentoir GN buffet bambou

**GN buffet bamboo box**  
Caja GN bambú buffet  
Présentoir GN buffet bambou



1/1

REF	Mod	H cm	🛒/📦	€/u
P595110	1/1	10	1/1	90,65
P595111	1/1	20	1/1	115,50



1/2

REF	Mod	H cm	🛒/📦	€/u
P595120	1/2	10	1/1	63,20
P595121	1/2	20	1/1	79,65

**GN buffet bamboo box**  
Caja GN bambú buffet  
Présentoir GN buffet bambou

**Tray - Lid for GN buffet bamboo box**  
Bandeja - Tapa para caja GN bambú buffet  
Plateau - Couvercle pour présentoir GN buffet bambou



1/3

REF	Mod	H cm	🛒/📦	€/u
P595130	1/3	10	1/1	54,50
P595131	1/3	20	1/1	68,95



REF	Mod	H cm	🛒/📦	€/u
P595100	1/1	2	1/3	52,45
P595200	1/2	2	1/4	35,35
P595300	1/3	2	1/6	33,40

Suitable for  
Compatible con / Adaptable pour



P. 425

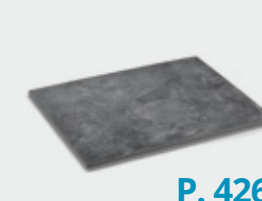

P. 426



P. 429



P. 499

## 14.2 Display stands & baskets

Presentación y expositores / Présentoirs et présentoirs corbeilles

AA  
Anodized  
Aluminum

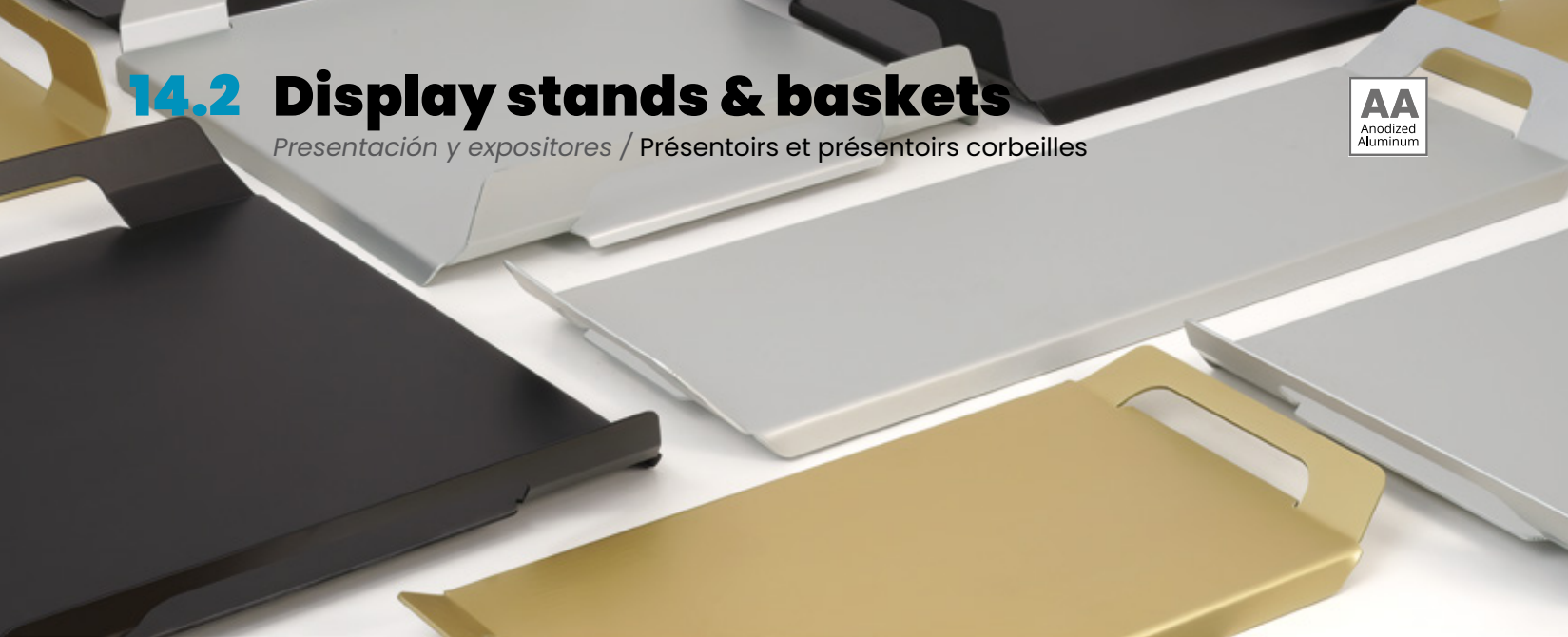

Available in 3 colours: black, silver and gold in a matt finish.

Stackable.

Suitable for food contact.

Double functionality: tray and riser.

Made from 2 mm thick anodised aluminium providing great strength and toughness.

Disponibles en 3 colores: negro, plata y dorado en acabado mate.

Apilables.

Apta para contacto alimentario.

Doble funcionalidad: bandeja y riser.

Realizado en aluminio adonizado de 2 mm de grosor que ofrece gran robustez y resistencia.

Disponibles en 3 couleurs : noir, argent et doré en finition mate.

Empilables.

Adapté au contact alimentaire.

Double fonctionnalité : plateau et riser.

Fabriqué en aluminium anodisé de 2 mm d'épaisseur, ce qui lui confère une grande robustesse et une grande résistance.

GN 1/1 buffet tray  
Bandeja buffet GN 1/1  
Plateau buffet GN 1/1

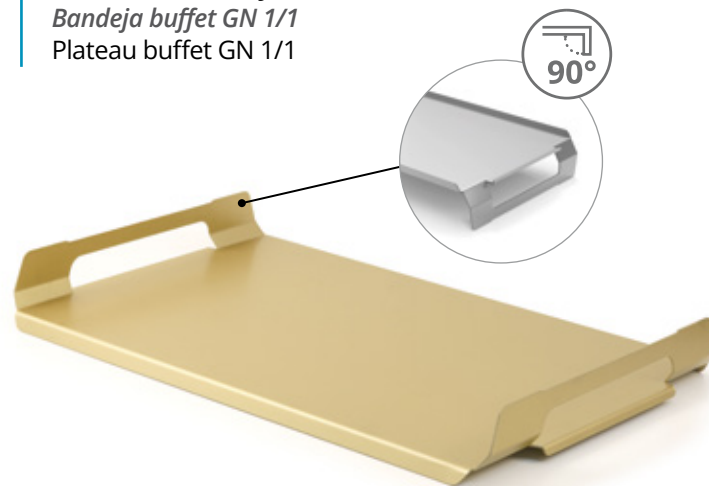

Ref. colour / Ref. color / Ref. couleur couvercle



**IDEA!** P317500B / P317500S / P317500G  
Adaptable to GN 1/1 trolleys and food transport boxes with guides.  
Adaptables a carros GN 1/1 y cajas de transporte de alimentos con guías.  
Adaptables aux chariots GN 1/1 et aux caisses de transport de nourriture avec guides.

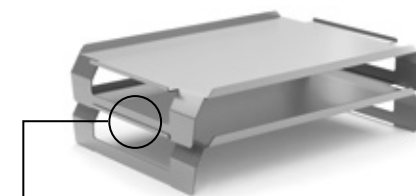

Click on the top of the handle to stack the trays stable and secure.

Encaje en la parte superior del asa para apilar las bandejas de forma estable y segura.

Enclenchez le dessus de la poignée pour empiler les plateaux de manière stable et sécurisée.

REF	Ext. measures Medidas ext. Dimensions ext. W x D x H cm	Usable surface Superficie útil Surface utile cm	€ / u
P317500B	53 x 32,5 x 6,5	49,2 x 31	50,15
P317500S	53 x 32,5 x 6,5	49,2 x 31	50,15
P317500G	53 x 32,5 x 6,5	49,2 x 31	50,15

AA  
Anodized  
Aluminum



dishwasher

## Display stands & baskets 14.2

Presentación y expositores / Présentoirs et présentoirs corbeilles

Service and buffet trays  
Bandejas de servicio y buffet  
Plateaux de service et de buffet

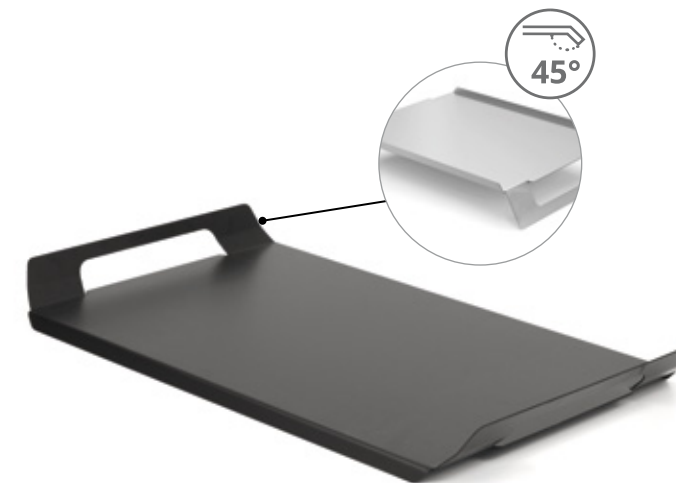

REF	Ext. measures Medidas ext. Dimensions ext. W x D x H cm	Usable surface Superficie útil Surface utile cm	€ / u
P317100B	53 x 32,5 x 4,6	45,5 x 31	51,60
P317100S	53 x 32,5 x 4,6	45,5 x 31	51,60
P317100G	53 x 32,5 x 4,6	45,5 x 31	51,60

Service and buffet trays  
Bandejas de servicio y buffet  
Plateaux de service et de buffet

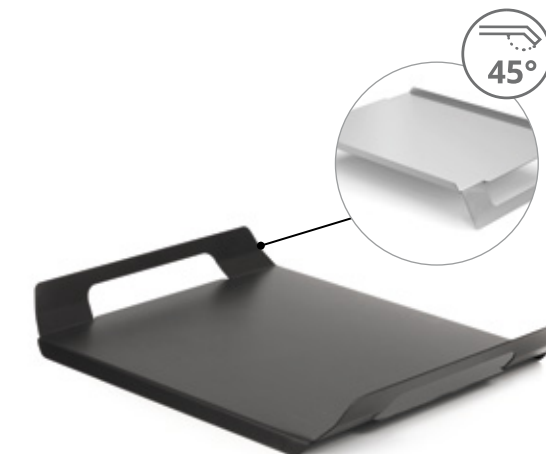

REF	Ext. measures Medidas ext. Dimensions ext. W x D x H cm	Usable surface Superficie útil Surface utile cm	€ / u
P317200B	43,4 x 32,5 x 4,6	36 x 31	41,50
P317200S	43,4 x 32,5 x 4,6	36 x 31	41,50
P317200G	43,4 x 32,5 x 4,6	36 x 31	41,50

Service and buffet trays  
Bandejas de servicio y buffet  
Plateaux de service et de buffet

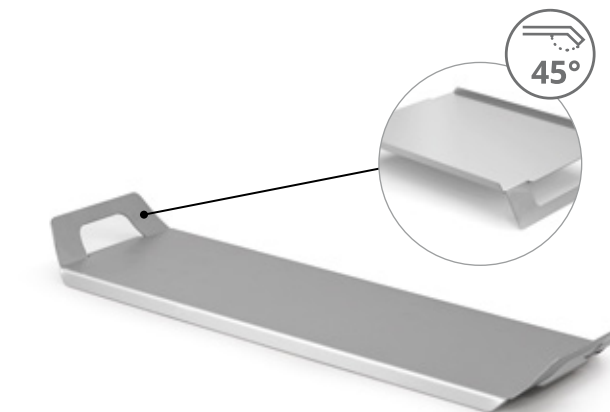

REF	Ext. measures Medidas ext. Dimensions ext. W x D x H cm	Usable surface Superficie útil Surface utile cm	€ / u
P317300B	51,5 x 18,5 x 4	45,5 x 17	37,65
P317300S	51,5 x 18,5 x 4	45,5 x 17	37,65
P317300G	51,5 x 18,5 x 4	45,5 x 17	37,65

Tray in anodized aluminium  
Bandeja servicio en aluminio anodizado  
Plateau service en aluminium anodisé

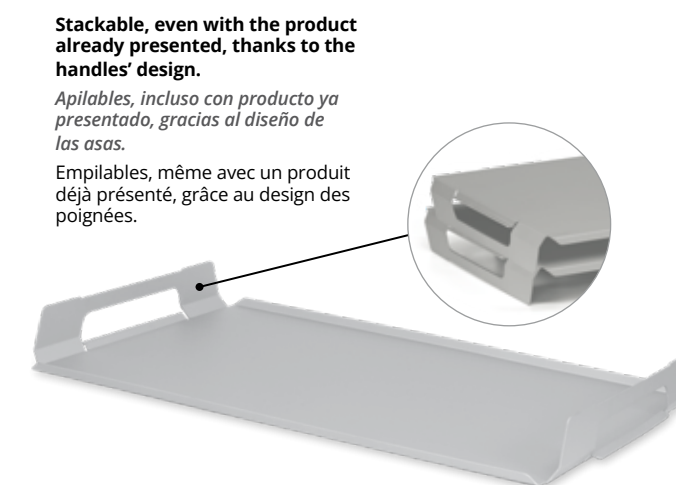

REF	Ext. measures Medidas ext. Dimensions ext. W x D x H cm	Usable surface Superficie útil Surface utile cm	€ / u
P317600S	60 x 40 x 6,5	57 x 37	61,35

Stackable, even with the product already presented, thanks to the handles' design.  
Apilables, incluso con producto ya presentado, gracias al diseño de las asas.  
Empilables, même avec un produit déjà présenté, grâce au design des poignées.

## 14.2 Display stands & baskets

Presentación y expositores / Présentoirs et présentoirs corbeilles



**Crown golden buffet mini riser**  
Expositor dorado mini Crown  
Support buffet doré mini Crown

NEW

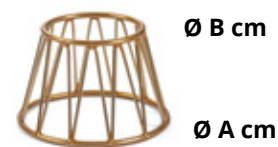

REF	Ø A cm	Ø B cm	H cm		€/u
P597230	15	10	10	1/6	7,95

**Crown golden buffet stand**  
Soporte para buffet dorado Crown  
Présentoir buffet doré Crown

NEW



REF	Ø A cm	Ø B cm	H cm		€/u
P597220	25	21	10	1/6	13,85

**Crown golden buffet stand**  
Soporte para buffet dorado Crown  
Présentoir buffet doré Crown

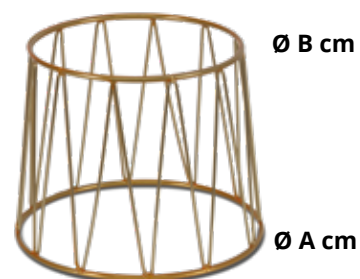

REF	Ø A cm	Ø B cm	H cm		€/u
P597200	25	21	20	1/6	17,20

**Crown golden buffet stand**  
Soporte para buffet dorado Crown  
Présentoir buffet doré Crown

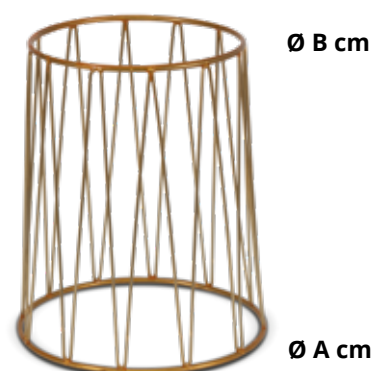

REF	Ø A cm	Ø B cm	H cm		€/u
P597210	25	21	30	1/6	19,95

**Golden buffet stand**  
Soporte para buffet dorado  
Présentoir buffet doré



REF	Ø cm	H cm		€/u
P597180	21,5	19	1/6	19,35

**Buffet stand**  
Soporte para buffe  
Présentoir buffet



REF	Ø cm	H cm		€/u
P597190	21,5	19	1/6	19,35

## Display stands & baskets 14.2

Presentación y expositores / Présentoirs et présentoirs corbeilles



**Buffet stand**  
Soporte para buffet  
Présentoir buffet

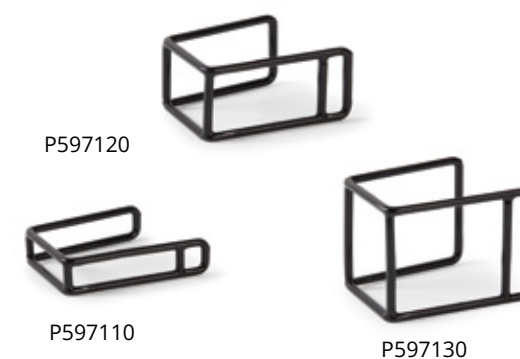

REF	W x D x H cm		€/u
P597110	12,5 x 10,5 x 3	1/24	6,80
P597120	12,5 x 10,5 x 6	1/24	8,10
P597130	12,5 x 10,5 x 9	1/24	9,55

**Set of 3 Square Bent Risers**  
Juego 3 expositores ángulos redondos  
Jeu de 3 socles carrés aux angles arrondis

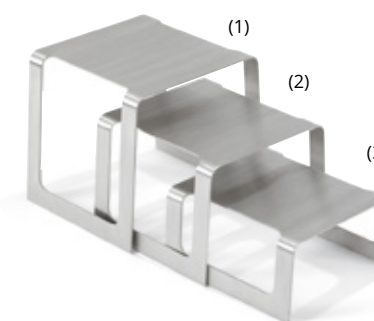

**Brushed Stainless Steel**  
Acero inoxidable pulido  
Inox brossé

REF	W x D x H cm		€/u
46009	(1) 20,3 x 20,3 x 20,3	1/1	235,55
	(2) 20,3 x 19,1 x 15,2		
	(3) 20,3 x 17,8 x 10,2		

**Buffet stand**  
Soporte para buffet  
Présentoir buffet



REF	Ø A cm	Ø B cm	H cm		€/u
P597140	25	21	10	1/6	14,45
P597150	25	21	20	1/6	17,25
P597160	25	21	30	1/6	20,00

**Set of 3 Square Bent Risers**  
Juego 3 expositores ángulos redondos  
Jeu de 3 socles carrés aux angles arrondis



**Brushed Stainless Steel**  
Acero inoxidable pulido  
Inox brossé

**Black / Negro / Noir**

REF	W x D x H cm		€/u
4600960	(1) 20,3 x 20,3 x 20,3	1/1	287,30
	(2) 20,3 x 19,1 x 15,2		
	(3) 20,3 x 17,8 x 10,2		

# 14.3 Cool line

## Cookware body made of 18/10 stainless steel

Cuerpo en acero inoxidable 18/10  
Corps en acier inoxydable 18/10



## Special lid designed to hold on the side handle

Tapa con diseño especial para apoyo en asa lateral  
Couvercle spécial, conçu pour reposer sur la poignée

## Ergonomic handles made of cast st/steel

Asas ergonómicas fabricadas en acero inoxidable de fundición  
Anses en fonte d'acier inoxydable, ergonomiques

## Full Induction Base: 6,5 mm technical sandwich base (stainless steel - aluminium - stainless steel).

Fondo Full Induction: base técnica de 6,5 mm en sándwich (Acero Inoxidable - Aluminio - Acero Inoxidable).  
Fond Full Induction : base technique de 6,5 mm en sandwich (acier inoxydable - aluminium - acier inoxydable).

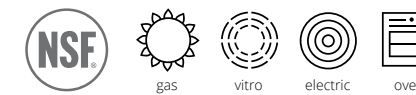

# Cool line 14.3

Ref. colour / Ref. color / Ref. couleur couvercle

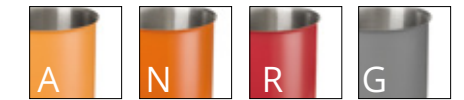

## Sauce pot with lid Cacerola alta con tapa Braising pot with lid

18/10  
Stainless steel



REF	Ø cm	H cm	Lts	🛒/📦	€/u
P490620 + COLOR	20	13,0	3,7	1/1	113,25
P490624 + COLOR	24	14,0	5,8	1/1	130,80
P490628 + COLOR	28	17,5	9,5	1/1	159,15
P490632 + COLOR	32	19,0	14,0	1/1	176,05

## Casserole with lid Cacerola baja con tapa Faitout with lid

18/10  
Stainless steel



REF	Ø cm	H cm	Lts	🛒/📦	€/u
P490724 + COLOR	24	9,5	3,9	1/1	126,95
P490728 + COLOR	28	11,0	5,8	1/1	145,65
P490732 + COLOR	32	12,5	8,9	1/1	164,85

## Paella pan with lid Paellera con tapa Paella pan with lid

18/10  
Stainless steel



REF	Ø cm	H cm	Lts	🛒/📦	€/u
P490928 + COLOR	28	6,0	3,7	1/1	145,65
P490932 + COLOR	32	6,0	4,7	1/1	164,85

## Saucepan Cazo recto Casserole

18/10  
Stainless steel



REF	Ø cm	H cm	Lts	🛒/📦	€/u
P490016 + COLOR	16	7,5	1,5	1/1	52,30

## Lid holder Soporte para tapas Support de couvercle

SS  
Stainless steel

PVC



NEW

Non-slip coating  
Revestimiento antideslizante  
Revêtement antidérapant

REF	W x D x H cm	🛒/📦	€/u
P597240	11,5 x 11,5 x 4	1/12	4,95



# 14.3 Cool line



**Non-stick sandwich bottom GN container**  
 Cubeta GN antiadherente con fondo difusor  
 Bac GN anti-adhésive avec fond thermo-diffuseur

**PATENTED EXCLUSIVE**



REF	Type Tipo	H mm	Lts	🛒/📦	€/u
P1106F3A	1/1	65	8,30	1/1	212,00
P1106F3N	1/1	65	8,30	1/1	212,00
P1106F3R	1/1	65	8,30	1/1	212,00
P1106F3G	1/1	65	8,30	1/1	212,00
P1106F3	1/1	65	8,30	1/1	212,00
P1206F3A	1/2	65	4,10	1/1	139,10
P1206F3N	1/2	65	4,10	1/1	139,10
P1206F3R	1/2	65	4,10	1/1	139,10
P1206F3G	1/2	65	4,10	1/1	139,10
P1206F3	1/2	65	4,10	1/1	139,10

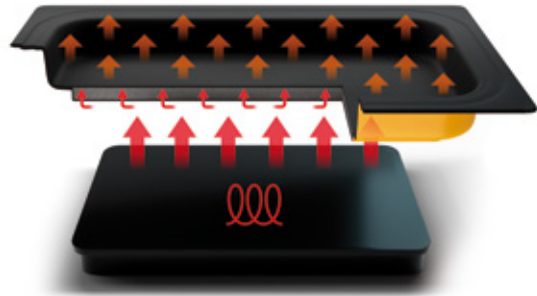

**IDEA!** Ideal for buffet presentations.  
 Ideal para presentación buffet.  
 Idéal pour présentation buffet.

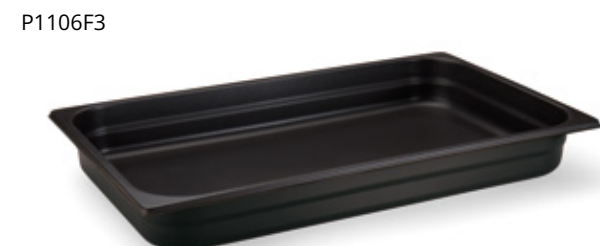

Ref. colour / Ref. color / Ref. couleur couvercle

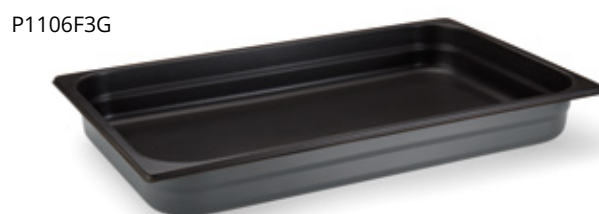

# Cool line 14.3

**IDEA!** Ideal for heated buffets  
 Ideal para buffet caliente  
 Idéal pour buffets chauffées

**Enamelled steel GN container**  
 Cubeta GN de acero esmaltado  
 Bac GN en acier émaillé



Suitable for all types of temperature-maintaining plates.

Apto para todo tipo de placa mantenedora de temperatura.  
 Convient à tous types de plaques de maintien en température.



REF	Type Tipo	H cm	🛒/📦	€/u
P131120	1/1	2,0	1/1	50,15
P131165	1/1	6,5	1/1	62,70
P131220	1/2	2,0	1/1	39,25
P131265	1/2	6,5	1/1	52,15

See products on  
 Ver productos en / Voir produits en page

P. 363

**Warming induction units**  
 Placas mantenedoras inducción  
 Plaques chauffantes à induction



## 14.3 Bronze cookware

Batería cocina bronce / Batterie de cuisine bronze

Transparent glass lid with stainless steel rim and black handle.

Tapa de cristal transparente con borde de acero inoxidable y mango en color negro.

Couvercle en verre transparent avec rebord en acier inoxydable et manche noir.

Escape valve for steam

Válvula de salida de vapor  
Clapet de sortie de la vapeur

Exterior painted in an elegant bronze colour.

Exterior pintado en elegante color bronce.

Extérieur avec revêtement bronze élégant.

Made of cast aluminium with high resistance to deformation and excellent thermal performance.

Fabricada en aluminio de fundición de gran resistencia a la deformación y con excelentes prestaciones térmicas.

Fabriqué en fonte d'aluminium très résistante à la déformation et doté d'excellentes performances techniques.

Ground base

Fondo torneado  
Fond dressé

## Elegant, robust, versatile

Elegante, robusta, versátil / Élégante, solide, polyvalente



**Rotisserie**  
*Rustidera*  
Plat à rôtir



REF	W x D x H cm	L		€/u
P152035B	35 x 25 x 7,5	5	1/6	82,80
P152935	Transparent lid Tapa transparente Couvercle transparent		1/1	21,70

**Deep casserole without lid**  
*Cazuela alta sin tapa*  
Braising sans couvercle



REF	Ø cm	H cm	L		€/u
P151020B	20	9	2,50	1/12	49,80
P151024B	24	10	4,00	1/6	60,30
P151028B	28	12	6,65	1/6	70,65

## Bronze cookware 14.3

Batería cocina bronce / Batterie de cuisine bronze

**Shallow casserole without lid**  
*Cazuela baja sin tapa*  
Cocotte sans couvercle



REF	Ø cm	H cm	L		€/u
P141024B	24	5,8	2,25	1/10	45,95
P141028B	28	7,5	4,00	1/6	59,45
P141032B	32	8,0	5,75	1/6	71,05

**Glass lid with stainless steel rim**  
*Tapa de cristal con borde de acero inoxidable*  
Couvercle en verre avec rebord en acier inoxydable



REF	Ø cm		€/u
P154020	20	1/1	10,30
P154024	24	1/1	11,65
P154028	28	1/1	12,90
P154032	32	1/1	14,20

See products on / Ver productos en / Voir produits en page

P. 86

BLACK SERIES



## 14.3 Miramar® cookware

Batería de cocina para presentación / Batterie de cuisine-Présentation



Cookware goes straight from the kitchen to your buffet in the same vessel.

Variety of cookware items for any menu.

La batería pasa directamente de la cocina a su buffet en el mismo recipiente.

Variación de utensilios de cocina para todo tipo de comidas.

Passez directement de la cuisine au buffet sans changer de plat.

Variété d'articles pour tout type de menu.



## Miramar® cookware 14.3

Batería de cocina para presentación / Batterie de cuisine-Présentation



Satin-finished interior and exterior

Asas y mangos brillantes  
Des poignées ultra-brillantes

Handle design serves as a convenient cover rest

Mangos diseñados para la sujeción de las tapas  
La conception des manches et poignées sert de reposecouvercle

Mirror-finished handles

Interior y exterior satinados  
Finition satinée à l'intérieur et l'extérieur

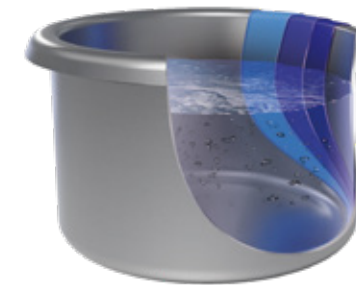
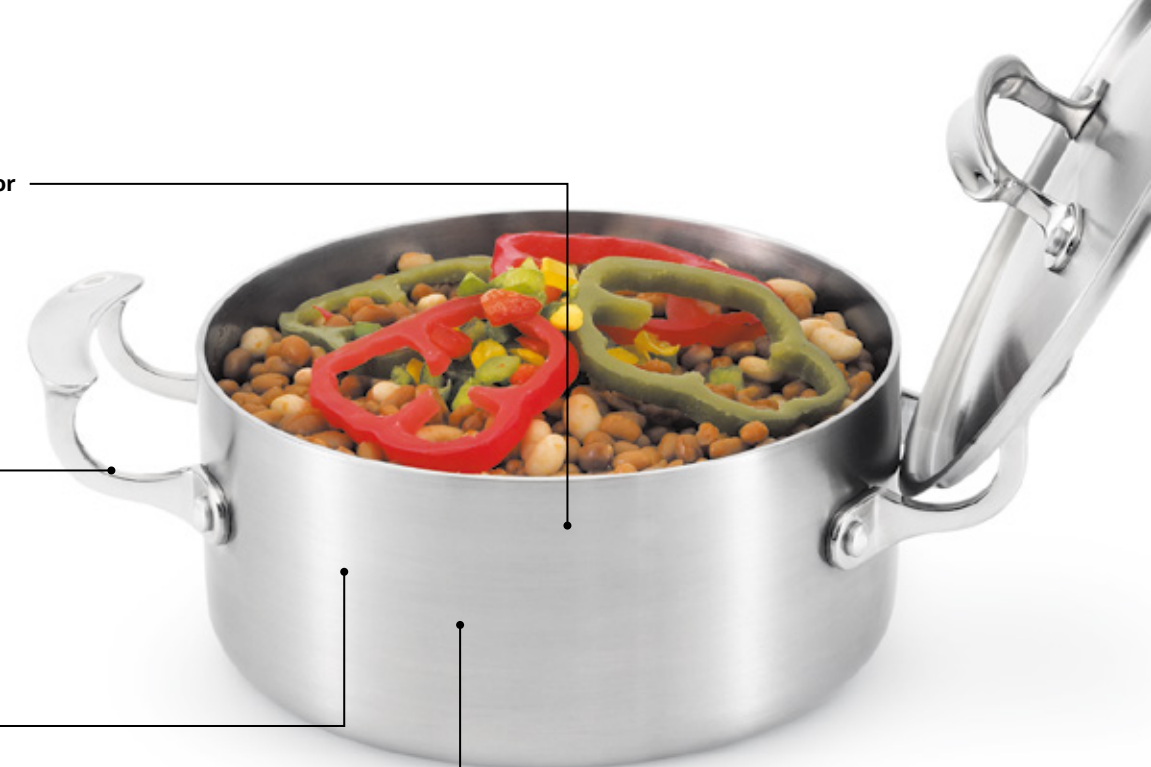

Extremely durable-thick 3-ply construction provides induction compatibility and will last a lifetime

Extremadamente duradero: la construcción gruesa de 3 capas proporciona compatibilidad con inducción y durará toda la vida

Extrêmement durable : la construction épaisse à 3 couches offre une compatibilité avec l'induction et durera toute une vie



# 14.3 Miramar® cookware

Batería de cocina para presentación / Batterie de cuisine-Présentation



## Casseroles

Cacerola baja con tapa  
Faitouts avec couvercle dôme bas



REF	Ø cm	H cm	L	🛒/📦	€/u
49410	20,0	9,5	2,9	1/1	128,50
49411	24,1	11,3	4,8	1/1	161,50
49441	25,8	18,9	6,6	1/1	222,50

## Bazier pan

Cacerola baja  
Plat à braiser



REF	Ø cm	H cm	L	🛒/📦	€/u
49425	30	8,9	6	1/1	143,30

## Sauté Pan

Sartén  
Sauteuse



REF	Ø cm	H cm	L	🛒/📦	€/u
49416	20,3	5,1	1,2	1/1	78,45
49413	26,0	4,8	2,1	1/1	112,85

## French Omelet Pans

Paellera  
Poêle à omelette



REF	cm	H cm	L	🛒/📦	€/u
49417	20,3 x 20,3	6	1,7	1/1	111,00
49424	26 x 26	6	2,9	1/1	116,25

## Stir Fry Pan

Sautex bombeado  
Wok/plat de service



REF	Ø cm	H cm	L	🛒/📦	€/u
49418	30,2	9,4	4,9	1/1	157,20
49428	32,1	9,2	6,0	1/1	148,20

## Sauce Pans

Cazo  
Casserole



REF	Ø cm	H cm	L	🛒/📦	€/u
49414	15,9	9,5	1,9	1/1	101,35
49430	14,0	6,8	0,9	1/1	98,40

# Miramar® cookware 14.3

Batería de cocina para presentación / Batterie de cuisine-Présentation



## Food Pans

Fuente  
Plat



REF	For / Para / Pour	W x D x H cm	L	🛒/📦	€/u
49434	-	29,5 x 23,6 x 5,1	2,6	1/1	131,70
49432	-	37,3 x 30 x 5,1	4,4	1/1	153,85
49435W	-	29,5 x 23,6 x 5,1	2,6	1/1	152,65
49433W	-	37,3 x 30 x 5,1	4,4	1/1	177,05
49434C	49434 - 49435W	29,5 x 23,5 x 6,4	-	1/6	52,75
49432C	49432 - 49433W	37,3 x 30 x 6,4	-	1/4	62,75

## Oval Au Gratin

Fuente para gratinar  
Plat à gratin ovale



REF	For / Para / Pour	W x D x H cm	L	🛒/📦	€/u
49420	-	25,4 x 19,1 x 5,2	1,7	1/1	117,85
49420C	49420	25,4 x 19,1 x 6,4	-	1/6	49,90
49412*	-	30,5 x 21,6 x 5,1	2,5	1/1	122,05
49412C*	49412	30,5 x 21,6 x 6,4	-	1/6	67,00
49442	-	40,6 x 22,9 x 5,1	3,5	1/1	218,55
49442C	49442	40,6 x 22,9 x 6,4	-	1/1	77,10
49445	-	52,3 x 22,9 x 10,2	6,6	1/1	272,15

\* Mirror-finished interior  
Acabado brillante  
Ultra-brillant

## French Oven with cover

Fuente Horno con tapa  
Cocotte avec couvercle



REF	W x D x H cm	L	🛒/📦	€/u
49431	363 x 282 x 9,7	6,6	1/1	265,35

## Covers

Tapa  
Couvercles



REF	For / Para / Pour	Ø cm	H mm	🛒/📦	€/u
49429	49428	35,6	120	1/1	66,85
49426	49418 - 49425	32,4	102	1/1	61,55
49419	49416 - 49417	20,3	51	1/1	38,00
49423	49413 - 49424	27,3	51	1/1	41,70
49427	49430	14,9	51	1/1	27,00

## Oval presentation dish

Fuente presentación ovalada  
Fontaine de présentation ovale



REF	W x D x H cm	L	🛒/📦	€/u
8230210	33,3 x 22,5 x 6,4	1,9	1/1	127,40
8231420	48,4 x 30,2 x 5,1	2,8	1/1	168,55

## Rectangular presentation dish

Fuente presentación rectangular  
Fontaine de présentation rectangulaire



REF	W x D x H cm	L	🛒/📦	€/u
8231810	33,2 x 27 x 2,5	1,5	1/1	101,80
8230720	33,2 x 27 x 7	3,2	1/1	135,55

# 14.3 Miramar® cookware

Batería de cocina para presentación / Batterie de cuisine-Présentation

## TEMPLATES PLANTILLAS GABARITS

Stainless Steel Plain / Acero inox. / Inox  
Resin / Resina / Résine  
Night Sky / Negro / Bleu nuit

+150 °C



### One large and one small round

Plantilla agujeros redondo grande y pequeño  
Une grande découpe ronde et une petite découpe ronde

1/1



REF	cm		1/1	€ / u
8242014	53,6 x 32,4		1/1	249,95

### One large oval

Plantilla agujero oval grande  
Une grande découpe ovale

1/1



REF	cm		1/1	€ / u
8242314	53,6 x 32,4		1/1	249,95
8242310	53,6 x 32,4		1/1	200,55

### One large round and one small round

Plantilla agujeros redondo grande y pequeño  
Une grande découpe ronde et une petite découpe ronde

1/1



REF	cm		1/1	€ / u
8242414	53,6 x 32,4		1/1	249,95

### Two large round

Plantilla agujeros redondos grandes  
2 grandes découpes rondes

1/1



REF	cm		1/1	€ / u
8242514	53,6 x 32,4		1/1	249,95

### One large round

Plantilla agujero redondo grande  
Une grande découpe ronde

1/1

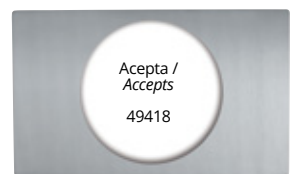

REF	cm		1/1	€ / u
8242614	53,6 x 32,4		1/1	249,95
8242610	53,6 x 32,4		1/1	200,55

### One large oval

Plantilla agujero oval grande  
Un grand ovale

1/1



REF	cm		1/1	€ / u
8242714	53,6 x 32,4		1/1	249,95
8242710	53,6 x 32,4		1/1	200,55

### Solid baseplate

Plantilla sólida  
Modèle solide

1/1



REF	cm		1/1	€ / u
8242814	53,6 x 32,4		1/1	249,95

### One small food pan

Plantilla para fuente  
Un petit bac à aliments

1/1



REF	cm		1/1	€ / u
8242814	53,6 x 32,4		1/1	249,95

### Two small food pans

Plantilla para fuente  
Deux petits bacs à aliments

1/1

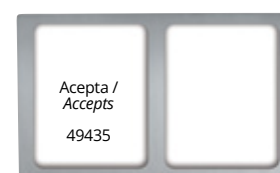

REF	cm		1/1	€ / u
8243014	53,6 x 32,4		1/1	249,95

### Two medium oval

Plantilla agujeros redondos medianos  
Deux découpes ovales moyennes

1/1



REF	cm		1/1	€ / u
8243214	53,6 x 32,4		1/1	249,95
8243210	53,6 x 32,4		1/1	200,55

### One large food pan

Plantilla para fuente  
Un grand bac à aliments

1/1

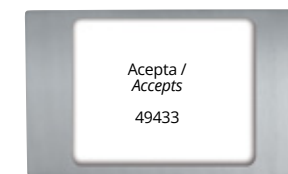

REF	cm		1/1	€ / u
8242914	53,6 x 32,4		1/1	249,95

### One large and one medium oval

Plantilla agujeros ovales grande y pequeño  
Une grande découpe ronde et une moyenne découpe ovale

1/1

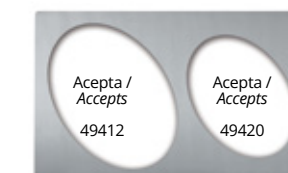

REF	cm		1/1	€ / u
8243114	53,6 x 32,4		1/1	249,95

### One large and one medium round

Plantilla agujeros redondos grande y mediano  
Une grande découpe ronde et une moyenne découpe ronde

1/1



REF	cm		1/1	€ / u
8243314	53,6 x 32,4		1/1	249,95

# 14.4 Super shapes

Buffet presentation steam table pans  
 Cubetas presentación buffet / Bacs présentation buffet

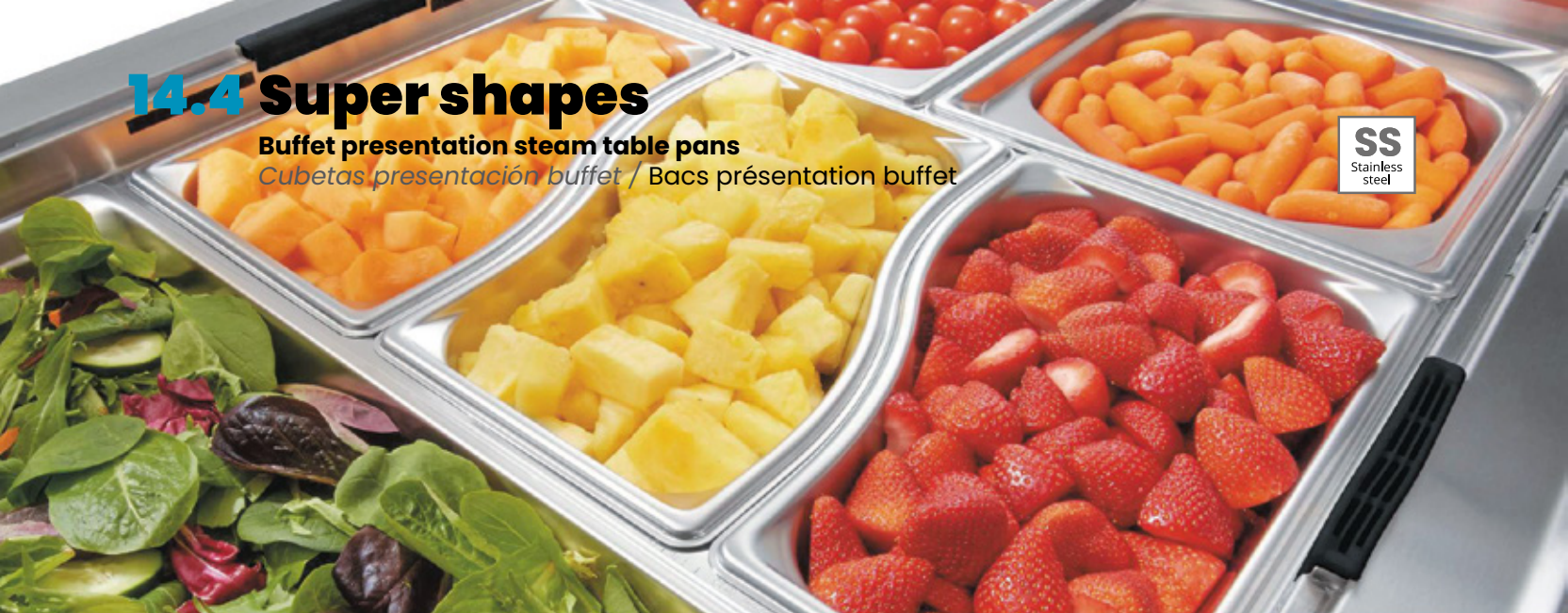

SS  
Stainless steel

**Full Oval**  
 Ovalada  
 Ovale

NSF

1/1



REF	W x D x H cm	L	🛒/📦	€/u
3101015	53 x 32,5 x 5,1	3,7	1/6	74,85
3101020	53 x 32,5 x 6,5	4,6	1/6	82,85
3101040	53 x 32,5 x 10	7,8	1/6	99,40

**Half Oval**  
 Óvalo  
 Ovale

NSF

1/2



REF	cm	L	🛒/📦	€/u
3102015	26,5 x 32,5 x 5,1	1,6	1/6	48,45
3102020	26,5 x 32,5 x 6,5	2,1	1/6	53,60
3102040	26,5 x 32,5 x 10	3,5	1/6	65,55

**Full Hexagon**  
 Hexágono  
 Hexagonal

NSF

1/1



REF	W x D x H cm	L	🛒/📦	€/u
3101220	53 x 32,5 x 6,5	5,0	1/6	73,90
3101240	53 x 32,5 x 10	8,8	1/6	95,50

**Full Hexagon**  
 Hexágono  
 Hexagonal

NSF

1/2



REF	W x D x H cm	L	🛒/📦	€/u
3102220	26,5 x 32,5 x 6,5	2,1	1/6	48,10

**Full Kidney**  
 Reniforme  
 Rein

NSF

1/1



REF	W x D x H cm	L	🛒/📦	€/u
3101120	53 x 32,5 x 6,5	4,8	1/6	74,85

# Super shapes 14.4

Buffet presentation steam table pans  
 Cubetas presentación buffet / Bacs présentation buffet

SS  
Stainless steel

**Half Kidney**  
 Reniforme  
 Rein

NSF

1/2



REF	W x D x H cm	L	🛒/📦	€/u
3102120	26,5 x 32,5 x 6,5	2,1	1/6	48,45

**Long Wild Pan**  
 Wild Pan larga  
 Wild Pan long

NSF

2/4



REF	W x D x H cm	L	🛒/📦	€/u
3100020	53 x 16,5 x 6,5	3,5	1/6	66,80
3100040	53 x 16,5 x 8,9	4,8	1/6	89,95

**Short Wild Pan**  
 Wild Pan corta  
 Wild Pan court

NSF

1/2



REF	W x D x H cm	L	🛒/📦	€/u
3100220	26,5 x 32,5 x 6,5	3,9	1/6	66,00
3100240	26,5 x 32,5 x 10	6,1	1/6	86,55

**Third Outer Wild Pan**  
 Wild Pan externa  
 Troisième Wild Pan extérieur

NSF

1/3



REF	W x D x H cm	L	🛒/📦	€/u
3100320	17,6 x 32,5 x 6,5	2,5	1/6	46,70
3100340	17,6 x 32,5 x 10	3,6	1/6	63,75

**Inner Wild Pan**  
 Wild Pan interna  
 Troisième Wild Pan intérieur

NSF

1/3



REF	W x D x H cm	L	🛒/📦	€/u
3100321	17,6 x 32,5 x 6,5	2,5	1/6	46,70
3100341	17,6 x 32,5 x 10	3,6	1/6	63,75

**Adaptor Bar**  
 Barra adaptadora  
 Barre intermédiaire

NSF

REF	For / Para / Pour	🛒/📦	€/u
75015	3100020 / 3100040	1/12	24,70
75013	3100220 / 3100240 / 3100320 / 3100321 / 3100340 / 3100341	1/12	23,50

# 14.5 CUBIC®

EXCLUSIVE  
PATENT PENDING

Modularity that reflects maximum expression  
*Modularidad a la máxima expresión*  
Modularité à son expression maximale



Discover the best buffet display, thanks to its:

- It allows to optimize exhibition space
- It reduces assembly and disassembly time
- Ease of transport and storage
- Elegant and original
- It offers multiple and varied combinations

Descubre la mejor presentación de buffet, porque:

- Permite optimizar espacio de exposición
- Reduce el tiempo de montaje y desmontaje
- Facilidad de transporte y almacenaje
- Elegante y original
- Ofrece múltiples y variadas combinaciones

Découvrez la meilleure présentation buffet, grâce à son :

- Permet d'optimiser l'espace d'exposition
- Réduit le temps de montage et de démontage
- Facilité de transport et de stockage
- Élégant et original
- Offre des combinaisons multiples et variées



**CUBES / CUBO / CUBES**  
Top cover convertible on mini shelf, stackable, multicombinations, saving space when storing parts, special waterproof treatment.

Con tapa superior transformable en mini estante, apilables entre sí, múltiples combinaciones posibles, ahorro de espacio durante el almacenaje de las piezas, tratamiento hidrófugo especial.

Couvercle transformable en mini rayon, empilables, multiples combinaisons possibles, gain d'espace pour le stockage des composants, traitement hydrofuge spécial.

**SHELVES / ESTANTES / TABLETTES**  
Three lengths: 50, 80 and 100 cm, two depths: 18 and 35 cm, undeformable wood. Special waterproof treatment.

Tres longitudes: 50, 80 y 100 cm, dos profundidades: 18 y 35 cm, madera indeformable. Tratamiento hidrófugo especial.

Trois longueurs: 50, 80 et 100 cm, deux profondeurs: 18 et 35 cm. Bois indéformable. Traitement hydrofuge spécial.

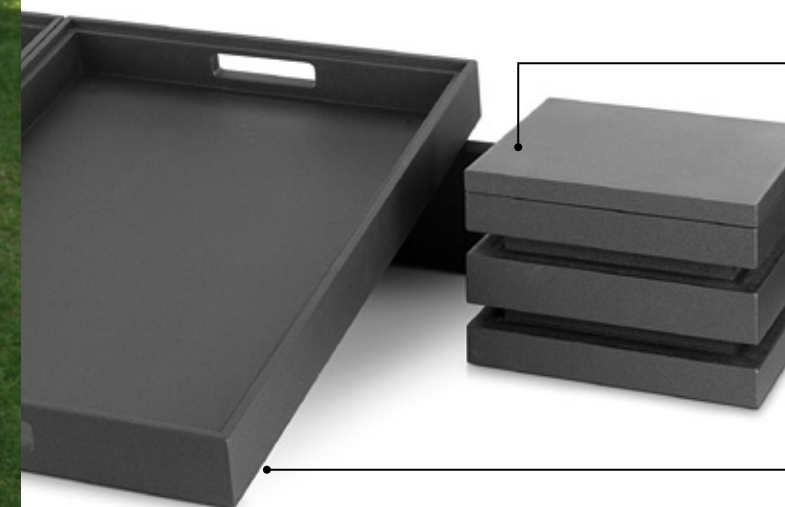
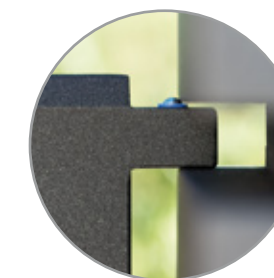

**Stackable trays**  
Bandejas apilables entre sí  
Plateaux empilables entre eux

# 14.5 Cubic

## Display buffet cases Muebles presentación buffet Meubles présentation buffet

**Suitable for gastronorm sizes**  
Adaptado a medidas gastronorm  
Adaptés aux mesures gastronorme

**Made of wood with special waterproof treatment, easy to clean**

Fabricados en madera con tratamiento hidrófugo especial, de fácil limpieza

Fabriqué en bois avec un traitement hydrofuge spécial, facile à nettoyer



# Cubic 14.5

**Presentation kit for 4 square bowls**  
Conjunto soporte 4 bols cuadrados  
Kit support 4 bols carrés

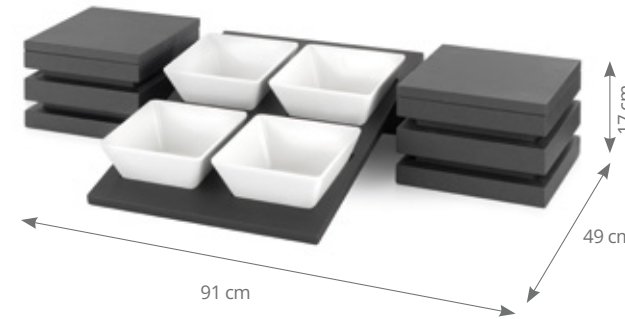

<b>Includes :</b>	<i>Incluye:</i>	<b>Inclus :</b>
2 cubes with lid	2 cubos con tapa	2 cubos avec couvercle
1 crossbar 50 cm length	1 travesaño de 50 cm	1 longeron 50 cm
1 displayer for 4 bowls	1 presentador de 4 bols	1 présentoir pour 4 bols
4 melamine bowls.	4 bols de melamina.	4 bols mélamine.

REF		€/ u
P905504	1/1	416,80

**Presentation kit for 6 square bowls**  
Conjunto soporte 6 bols cuadrados  
Kit support 6 bols carrés

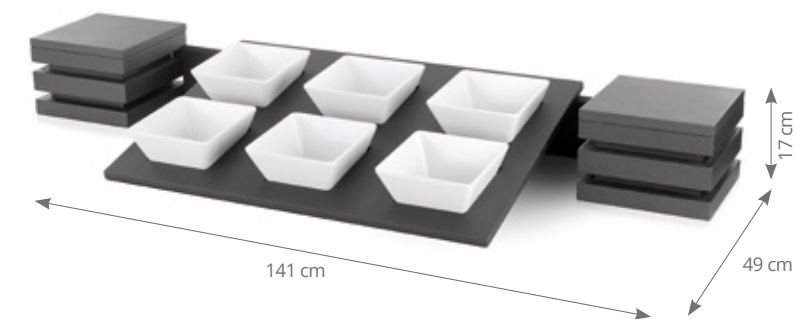

<b>Includes :</b>	<i>Incluye:</i>	<b>Inclus :</b>
2 cubes with lid	2 cubos con tapa	2 cubos avec couvercle
1 crossbar 100 cm length	1 travesaño de 100 cm	1 longeron 100 cm
1 displayer for 6 bowls	1 presentador de 6 bols	1 présentoir pour 6 bols
6 melamine bowls.	6 bols de melamina.	6 bols mélamine.

REF		€/ u
P905506	1/1	454,65

## Wooden buffet serving trolley Carro madera presentación buffet Chariot buffet en bois présentation buffet

**Outstanding combination of wood and aluminium**  
Elegante combinación de madera y aluminio  
Combinaison élégante en bois et en aluminium

**Suitable for gastronorm sizes**  
Adaptado a medidas gastronorm  
Adaptés aux mesures gastronorme

**Possible transformation from an expositor trolley to a presentation table**

Posibilidad de convertir el carro expositor en mesa de presentación

Possibilité de transformer le chariot d'exposition en une table de présentation

**Wood with special waterproof treatment, easy to clean**  
Tratamiento hidrófugo especial, de fácil limpieza  
Bois avec un traitement hydrofuge spécial, facile à nettoyer



**Two levels presentation kit for 6 square bowls**  
Conjunto 2 niveles soporte 6 bols  
Kit support 6 bols carrés deux niveaux

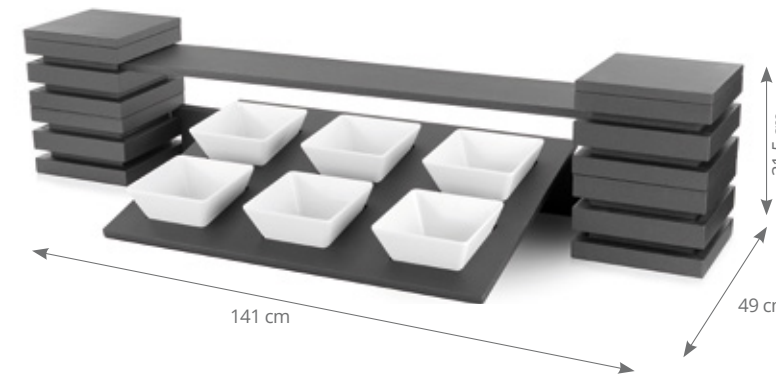

<b>Includes :</b>	<i>Incluye:</i>	<b>Inclus :</b>
4 cubes with lid	4 cubos con tapa	4 cubos avec couvercle
1 crossbar 100 cm length	1 travesaño de 100 cm	1 longeron 100 cm
1 displayer for 6 bowls	1 presentador de 6 bols	1 présentoir pour 6 bols
6 melamine bowls	6 bols de melamina	6 bols mélamine
1 narrow shelf 100 cm	1 estante estrecho de 100 cm	1 tablette étroite 100 cm

REF		€/ u
P905516	1/1	744,35

**Presentation kit for 8 square bowls**  
Conjunto soporte 8 bols cuadrados  
Kit support 8 bols carrés

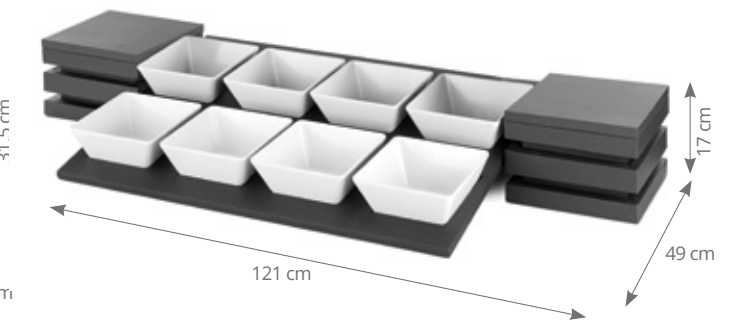

<b>Includes :</b>	<i>Incluye:</i>	<b>Inclus :</b>
2 cubes with lid	2 cubos con tapa	2 cubos avec couvercle
1 crossbar 80 cm length	1 travesaño de 80 cm	1 longeron 80 cm
2 displayers for 4 bowls	2 presentadores de 4 bols	2 présentoirs pour 4 bols
8 melamine bowls	8 bols de melamina	8 bols mélamine

REF		€/ u
P905508	1/1	472,70

# 14.5 Cubic

# Cubic 14.5

**Two levels presentation kit for 8 square bowls**  
*Conjunto 2 niveles soporte 8 bols*  
 Kit support 8 bols carrés deux niveaux

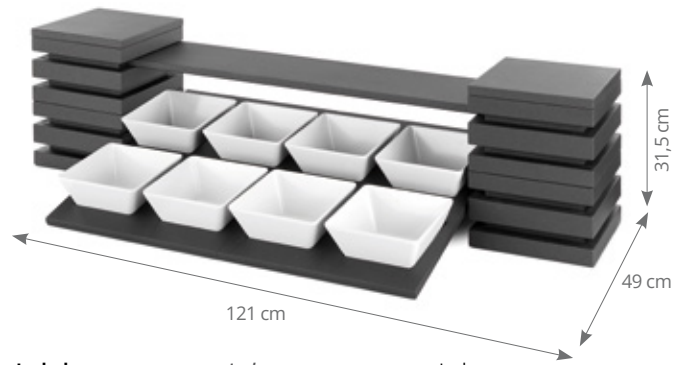

**Includes :**  
 4 cubes with lid  
 1 crossbar 80 cm length  
 2 displays for 4 bowls  
 8 melamine bowls  
 1 narrow shelf 80 cm

**Incluye:**  
 4 cubos con tapa  
 1 travesaño 80 cm  
 2 presentadores de 4 bols  
 8 bols de melamina  
 1 estante estrecho 80 cm

**Inclus :**  
 4 cubes avec couvercle  
 1 longeron 80 cm  
 2 présentoirs pour 4 bols  
 8 bols mélamine  
 1 tablette étroite 80 cm

REF € / u  
**P905518** 1/1 745,55

**Basic two levels presentation kit**  
*Conjunto básico estante 2 niveles*  
 Kit basique présentation 2 niveaux



**Includes :**  
 4 cubes with lid  
 1 wide shelf 100 cm  
 1 narrow shelf 100 cm

**Incluye:**  
 4 cubos con tapa  
 1 estante ancho 100 cm  
 1 estante estrecho 100 cm

**Inclus :**  
 4 cubes avec couvercle  
 1 tablette large 100 cm  
 1 tablette étroite 100 cm

REF € / u  
**P905400** 1/1 596,95

**Two levels presentation kit for 40x40 cm trays**  
*Conjunto 2 niveles bandejas 40x40 cm*  
 Kit présentation 2 niveaux pour plateaux 40x40 cm

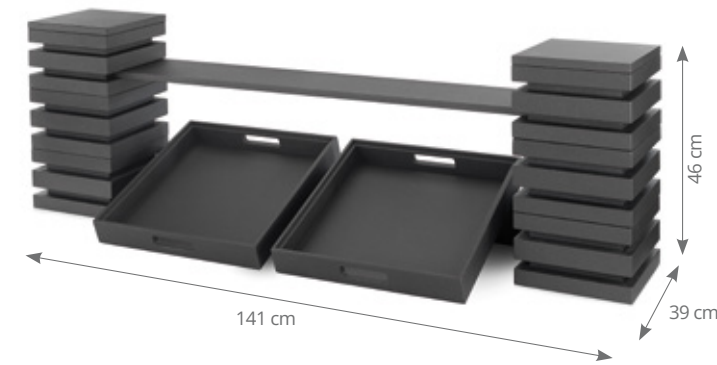

**Includes :**  
 6 cubes with lid  
 1 crossbar 100 cm length  
 2 serving trays 40 x 40 cm  
 1 narrow shelf 100 cm

**Incluye:**  
 6 cubos con tapa  
 1 travesaño de 100 cm  
 2 bandejas presentación de 40 x 40 cm  
 1 estante estrecho de 100 cm

**Inclus :**  
 6 cubes avec couvercle  
 1 longeron 100 cm  
 2 plateaux présentation 40 x 40 cm  
 1 tablette étroite 100 cm

REF € / u  
**P905310** 1/1 993,05

**Two trays 60x40 cm presentation kit**  
*Conjunto 2 bandejas 60x40 cm*  
 Kit présentation pour deux plateaux 60x40 cm

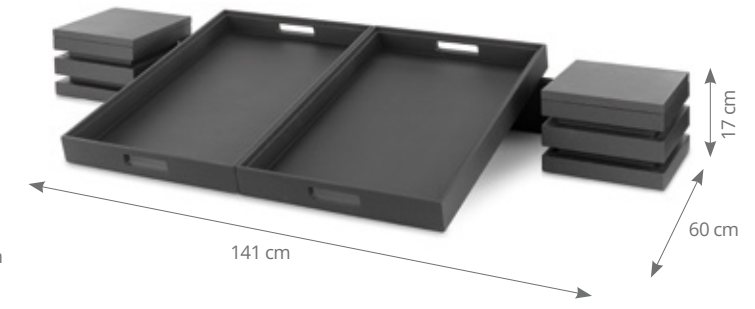

**Includes :**  
 2 cubes with lid  
 1 crossbar 100 cm length  
 2 serving trays 60 x 40 cm

**Incluye:**  
 2 cubos con tapa  
 1 travesaño de 100 cm  
 2 bandejas presentación de 60 x 40 cm

**Inclus :**  
 2 cubes avec couvercle  
 1 longeron 100 cm  
 2 plateaux présentation 60 x 40 cm

REF € / u  
**P905320** 1/1 516,25

**"L" shape two levels presentation kit**  
*Conjunto estante dos niveles forma "L"*  
 Kit présentation "L" 2 niveaux

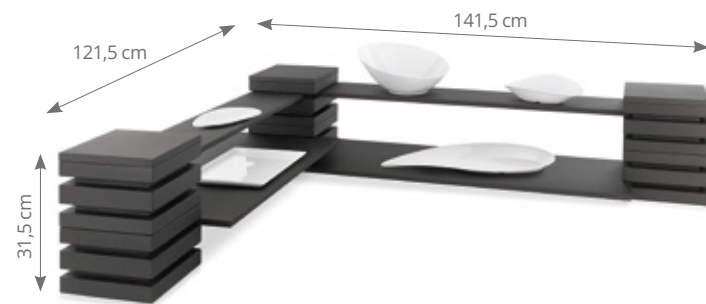

**Includes :**  
 6 cubes with lid  
 1 wide shelf 100 cm  
 1 narrow shelf 100 cm  
 1 wide shelf 80 cm  
 1 narrow shelf 80 cm

**Incluye:**  
 6 cubos con tapa  
 1 estante ancho 100 cm  
 1 estante ancho 80 cm  
 1 estante estrecho 80 cm

**Inclus :**  
 6 cubes avec couvercle  
 1 tablette large 100 cm  
 1 tablette étroite 100 cm  
 1 tablette large 80 cm  
 1 tablette étroite 80 cm

REF € / u  
**P905410** 1/1 945,25

**Two trays 40x40 cm presentation kit**  
*Conjunto 2 bandejas presentación 40x40 cm*  
 Kit présentation pour deux plateaux 40x40 cm



**Includes :**  
 4 cubes with lid  
 1 crossbar 100 cm length  
 2 serving trays 40 x 40 cm

**Incluye:**  
 4 cubos con tapa  
 1 travesaño de 100 cm  
 2 bandejas presentación de 40 x 40 cm

**Inclus :**  
 4 cubes avec couvercle  
 1 longeron 100 cm  
 2 plateaux présentation 40 x 40 cm

REF € / u  
**P905300** 1/1 715,20

**Two levels for trays 60x40 cm presentation kit**  
*Conjunto 2 niveles para bandejas 60x40 cm*  
 Kit présentation 2 niveaux pour plateaux 60x40 cm

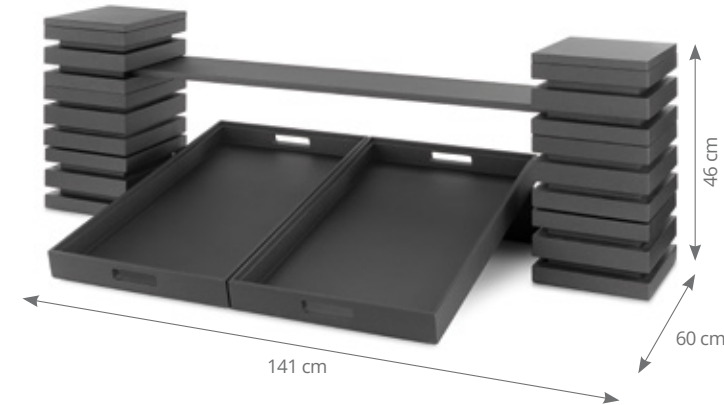

**Includes :**  
 6 cubes with lid  
 1 crossbar 100 cm length  
 2 serving trays 60 x 40 cm  
 1 narrow shelf 100 cm

**Incluye:**  
 6 cubos con tapa  
 1 travesaño de 100 cm  
 2 bandejas presentación de 60 x 40 cm  
 1 estante estrecho de 100 cm

**Inclus :**  
 6 cubes avec couvercle  
 1 longeron 100 cm  
 2 plateaux présentation 60 x 40 cm  
 1 tablette étroite 100 cm

REF € / u  
**P905340** 1/1 1.025,90

**Three levels 2/3 GN stand**  
*Expositor GN 2/3, tres niveles*  
 Présentoir 3 niveaux pour GN 2/3



**Includes / Incluye / Inclus :**  
 3 GN containers 2/3 20 mm  
 3 cubetas GN 2/3 20 mm  
 3 bags GN 2/3 20 mm



REF W x D x H cm € / u  
**P904790** 65 x 38 x 59 1/1 335,50

**GN skewer serving tray**  
Bandeja GN presentación pinchos  
Plateau GN présentation piques



GN 1/1

**Includes:**  
wooden tray  
oak melamine tray  
interior skewer stand

*Incluye:*  
bandeja madera  
bandeja melamina roble  
soporte interior pinchos

**Inclus:**  
plateau bois  
plateau mélamine chêne  
support intérieur piques

REF	W x D x H cm	Holes Agujeros Ø cm	Piques Pinchos	€ / u
P904350	53,9 x 33,5 x 7,7	0,4	84	278,20

**Buffet wine cooler**  
Enfriador botellas buffet  
Rafraîchisseur bouteilles

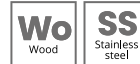

GN 1/1

**Includes:**  
wooden tray  
1/1 GN pan 150 mm

*Incluye:*  
bandeja madera  
cubeta GN 1/1 150 mm

**Inclus:**  
plateau bois  
bac GN 1/1 150 mm

REF	W x D x H cm	€ / u
P904155	57 x 37 x 14,5	183,30

**Napkin and tea & sugar bags dispenser**  
Servilletero y dispensador bolsas te y azúcar  
Distributeur serviettes et des saquettes thé & sucre



P904720



P904725

REF	W x D x H cm	€ / u
P904720	22 x 22 x 5,5	62,40
P904725	22 x 22 x 5,5	93,45

**Tea & sugar bag holder**  
Soporte bolsas te y azúcar  
Support pour saquettes de thé & sucre



For / Para / Pour ref. P904.720

REF	W x D x H cm	€ / u
P904721	19,8 x 19,8 x 4,9	33,70

**1/1 GN wooden table + cutting board**  
Mesita buffet GN 1/1 + taco madera  
Table GN 1/1 en bois + planche à découper



REF	W x D x H cm	€ / u
P904850	53 x 32,5 x 12	172,95

**Low wooden table + cutting board**  
Mesita buffet baja + taco madera  
Table basse en bois + planche à découper



P904820

P904810

REF	W x D x H cm	€ / u
P904810	32,5 x 22 x 12	136,30
P904820	32,5 x 22 x 16,5	151,70

**Methacrylate holder**  
Portamenús metacrilato  
Porte-menus méthacrylate



REF	cm	€ / u
P20072	6 x 6	8,10

**Cutting board for wooden table**  
Taco madera para mesita buffet  
Planche à découper pour table en bois



P904804



P904809

REF	W x D x H cm	€ / u
P904804 <sup>1</sup>	29,2 x 18,7 x 22	40,50
P904809 <sup>2</sup>	49,7 x 29,2 x 22	54,70

(1) For / Para / Pour P904810 / P904820  
(2) For / Para / Pour P904850

See products on / Ver productos en / Voir produits en page

P. 549

**Stainless steel plate covers**  
Tapas Acero inoxidable para platos  
Inox couvercles à assiette





## ROOM SERVICE

**Cutlery-holder tray**  
Bandeja porta-cubiertos  
Plateau porte-couverts



GN 1/1



Stackables.  
Apilables.  
Empilables.

**4 compartments**  
4 compartimentos  
4 compartiments  
**303 x 115 mm**

REF	W x D x H cm	Shopping icon	€ / u
P904780	53,9 x 33,5 x 7,7	1/1	153,70

**Serving tray**  
Bandeja servicio y presentación  
Plateau service et présentation



Stackables.  
Apilables.  
Empilables.

**IDEA!** Room service tray.  
Perfecta para servicio de habitaciones.  
Plateau idéal pour service de chambre.

REF	W x D x H cm	Shopping icon	€ / u
P904760	60 x 40 x 6,5	1/1	130,65

**Serving tray**  
Bandeja presentación  
Plateau présentation



Stackables.  
Apilables.  
Empilables.

REF	W x D x H cm	Shopping icon	€ / u
P904740	40 x 40 x 6,5	1/1	106,50

**1/1 GN serving tray**  
Bandeja servicio y presentación GN 1/1  
Plateau service et présentation GN 1/1



GN 1/1



Stackables.  
Apilables.  
Empilables.

**1/1 Gastronorm container not included.**  
No incluye cubeta gastronorm 1/1.  
Bac gastronorme 1/1 non inclus.

REF	W x D x H cm	Shopping icon	€ / u
P904711	53,9 x 33,5 x 7,7	1/1	115,85



**Wooden cube with lid**  
Cubo con tapa madera  
Cube en bois avec couvercle

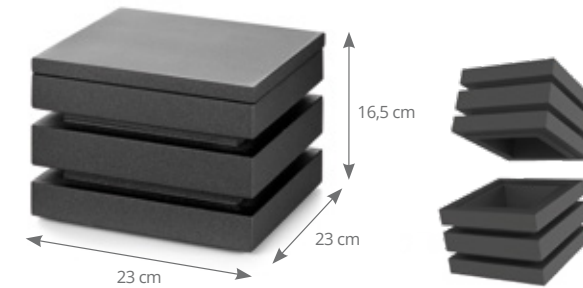

REF	Shopping icon	€ / u
P904600	1/1	125,85

**Wooden lid**  
Tapa madera  
Couvercle en bois



REF	Shopping icon	€ / u
P904660	1/1	21,15

**Wooden narrow shelf**  
Estante madera estrecho  
Tablette en bois étroite

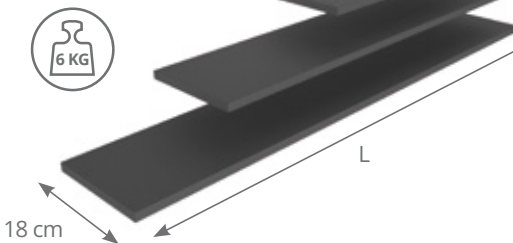

REF	L cm	Shopping icon	€ / u
P904650	50	1/1	44,45
P904680	80	1/1	54,40
P904610	100	1/1	55,60

**Wooden wide shelf**  
Estante madera ancho  
Tablette en bois large

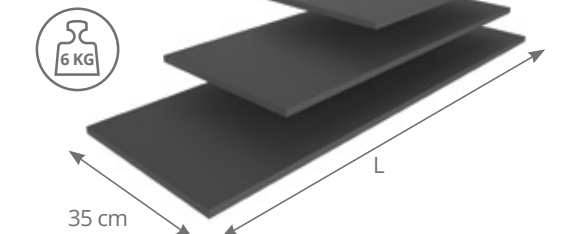

REF	L cm	Shopping icon	€ / u
P904652	50	1/1	71,85
P904682	80	1/1	93,25
P904612	100	1/1	96,35

**Displayer for 4 melamine bowls**  
Presentador 4 bols melamina cuadrados  
Présentoir 4 bols mélamine

For square bowls  
Para bols cuadrados  
Pour bols carrés  
**180 x 180**  
REF. P22.202

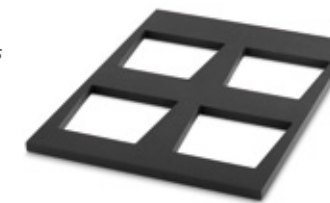

REF	W x D x H cm	Shopping icon	€ / u
P904937	37,5 x 50 x 1,5	1/1	89,05

**Displayer for 6 melamine bowls**  
Presentador 6 bols melamina cuadrados  
Présentoir 6 bols mélamine

For square bowls  
Para bols cuadrados  
Pour bols carrés  
**180 x 180**  
REF. P22.202

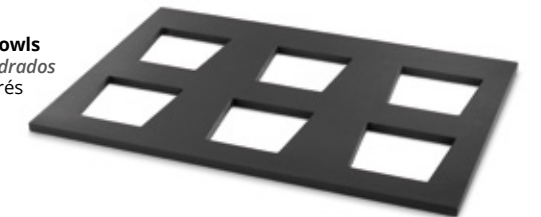

REF	W x D x H cm	Shopping icon	€ / u
P904975	75 x 50 x 1,5	1/1	104,90

**Crossbar buffet trays**  
Travesaño soporte bandejas  
Longerons pour plateaux buffet



**Perforated buffet display**  
Buffet perforado  
Buffet perforé



**Includes:**  
Wooden frame perforated 1/1 GN pan 65 mm gastronorm pan 1/1 20 mm roll-top lid.

**Incluye:**  
Marco madera bandeja perforada GN 1/1 65 mm cubeta GN 1/1 20 mm cúpula roll-top

**Inclus:**  
Cadre en bois bac GN 1/1 65 mm perforé bac GN 1/1 20 mm couvercle roll-top

REF	W x D x H cm		€ / u
P904165	57 x 37 x 31	1/1	269,90

**Standard buffet display**  
Buffet estandar  
Buffet standard



**Includes:**  
Wooden frame 2u. GN 1/1 20 mm roll-top lid

**Incluye:**  
Marco madera 2 u. cubeta GN 1/1 20 mm cúpula roll-top

**Inclus:**  
Cadre en bois 2 u. bacs GN 1/1 20 mm couvercle roll-top

REF	W x D x H cm		€ / u
P904120	57 x 37 x 31	1/1	254,40

**Isothermal mat**  
Tapete isotérmico  
Tapis isotherme



REF	W x D x H cm		€ / u
P904400	47 x 26 x 20	1/1	12,30

**Cooling plate**  
Placa enfriadora  
Plaque réfrigérante



Adjustable to 1/1 GN pan.  
Adaptable a cubeta GN 1/1.  
Adaptable à bac GN 1/1.

REF	W x D x H cm		€ / u
P904500	47,5 x 27,7 x 3	1/5	71,60

**Triple buffet display**  
Buffet triple  
Buffet triple



**Includes:**  
Wooden frame 3 units 1/3 GN pans 65 mm GN pan 1/1 20 mm roll-top lid.

**Incluye:**  
Marco madera 3 cubetas GN 1/3 65 mm cubeta GN 1/1 20 mm cúpula roll-top.

**Inclus:**  
Cadre en bois 3 bacs GN 1/3 65 mm bac GN 1/1 20 mm couvercle roll-top.

REF	W x D x H cm		€ / u
P904113	57 x 37 x 31	1/1	268,95

**Cheese buffet display**  
Buffet quesos  
Buffet fromage



**Includes:**  
Wooden frame wooden cutting board GN pan 1/1 20 mm roll-top lid.

**Incluye:**  
Marco madera bandeja corte madera cubeta GN 1/1 20 mm cúpula roll-top.

**Inclus:**  
Cadre en bois planque à découper en bois bac GN 1/1 20 mm couvercle roll-top.

REF	W x D x H cm		€ / u
P904140	57 x 37 x 31	1/1	300,10

**Melamine slate buffet displayer**  
Buffet pizarra melamina  
Mélamine buffet ardoise



**Includes:**  
Wooden frame melamine slate board 1/1 GN container 20 mm

**Incluye:**  
Marco madera tabla pizarra melamina cubeta GN 1/1 20 mm

**Inclus:**  
Cadre en bois plaque ardoise en mélamine bac GN 1/1 20 mm

REF	W x D x H cm		€ / u
P904160	57 x 37 x 14,5	1/1	216,95

**Bread buffet display**  
Buffet pan  
Buffet pain



**Includes:**  
Wooden frame bread cutting board 1/1 GN container 20 mm

**Incluye:**  
Marco madera cortador pan madera cubeta GN 1/1 20 mm

**Inclus:**  
Cadre en bois plaque à découper pain en bois bac GN 1/1 20 mm

REF	W x D x H cm		€ / u
P904145	57 x 37 x 14,5	1/1	200,60

**Wooden frame**  
Marco madera  
Cadre en bois



P904.200

REF	W x D x H cm		€ / u
P904200	57 x 37 x 14,5	1/1	133,95

**Wooden bread cutting board**  
Cortador pan madera  
Plaque à découper pain en bois



REF	W x D x H cm		€ / u
P904146	52 x 31,5 x 20	1/1	54,70

**Wooden bread cutting board**  
Cortador pan madera  
Plaque à découper pain en bois



REF	W x D x H cm		€ / u
P904142	53 x 32,5 x 2	1/1	88,95

EXCLUSIVE



**BUFFET TROLLEY WITH POSSIBLE TRANSFORMATION FROM AN EXPOSITOR TROLLEY TO A PRESENTATION TABLE**  
**CARRO BUFFET CON POSIBILIDAD DE CONVERTIR EL CARRO EXPOSITOR EN MESA DE PRESENTACIÓN**  
**CHARIOT BUFFET AVEC POSSIBILITÉ DE CONVERTIR LE CHARIOT D'EXPOSITION EN UNE TABLE DE PRÉSENTATION**



**Black buffet trolley for 4 1/1 GN inserts**  
*Carro buffet negro 4 GN 1/1*  
 Chariot buffet noir pour 4 bacs GN 1/1



REF	Type / Tipo		€/u
<b>P90490*</b>	4 X GN 1/1	1/1	1.558,15
<b>P90492</b>	Tapa / Cover / Tablette	1/1	152,65
<b>P90493</b>	Tapa / Cover / Tablette 1/1	1/1	54,70

**Outstanding combination of wood and aluminium**

*Elegante combinación de madera y aluminio*  
 Combinaison élégante en bois et en aluminium



**Wood with special waterproof treatment, easy to clean**  
*Madera con tratamiento hidrófugo especial, de fácil limpieza*  
 Bois avec un traitement hydrofuge spécial, facile à nettoyer

**Reinforcement bar**  
*Barra refuerzo nivel inferior*  
 Barre de renforcement



**Soundproof and revolving castors**  
 Ø 125 mm, with brakes

*Ruedas giratorias e insonoras de Ø 125 mm, con freno*

*Roulettes insonores et pivotantes de Ø 125 mm, avec freins*

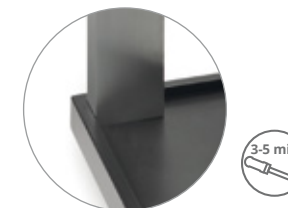

**Delivered flatpacked between 3 to 5 minutes assembly**

*Se suministran desmontados entre 3 a 5 minutos de montaje*

*Livrés démontés entre 3 et 5 minutes de montage*



**Suitable for gastronorm sizes**  
*Adaptado a medidas gastronorm*  
 Adapté aux mesures gastronorme

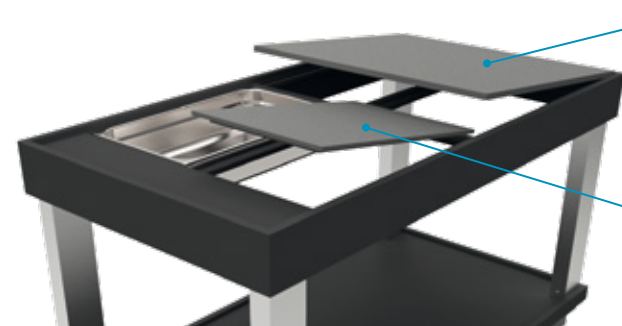

**\*Two cover are included on the price**  
*\*Dos tapas incluidas en precio*  
 \*Deux tablettes comprises dans le prix  
**P90492**

**Cover for 1/1 GN insert not included on the price**  
*Tapa individual encaje GN 1/1 no incluida en precio*  
 Tablette de bac GN 1/1 non comprise dans le prix  
**P90493**

# 14.5 Cubic

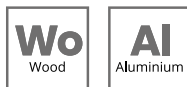

**Wooden-aluminium trolley 2 shelves**  
*Carro madera-aluminio 2 estanterías*  
 Chariot en bois-aluminium 2 plateaux

**Waterproof treatment**  
*Tratamiento hidrófugo*  
 Traitement hydrofuge



REF	Colour		€/u
P80220	Negro / Black / Noir	1/1	702,60

**Wooden gueridon trolley**  
*Gueridón o carro auxiliar madera*  
 Chariot guéridon en bois

**Waterproof treatment**  
*Tratamiento hidrófugo*  
 Traitement hydrofuge

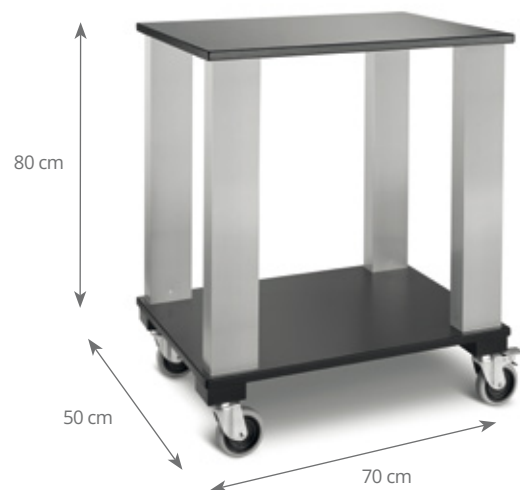

REF	Colour		€/u
P80219	Negro / Black / Noir	1/1	558,60

**Oak melamine gueridon trolley**  
*Carro guerdón melamina roble*  
 Chariot guéridon mélamine roure

**EXCLUSIVE**



REF		€/u
P80216	1/1	753,90

# Cubic 14.5

**Cutlery dispenser trolley**  
*Carro porta-cubiertos*  
 Chariot porte couverts



**EXCLUSIVE**



P908132



P90813



**Trays, dishes, GN containers and cutlery dispenser not included**  
*No incluye porta-cubiertos, cubetas GN, platos ni bandejas*  
 Ramasse-couverts, bacs GN, assiettes, et plateaux pas compris

REF		€/u
P908132	1/1	1.161,00
P90813	1/1	1.073,35

**Cutlery bin**  
*Porta-cubiertos*  
 Ramasse-couverts

**4 x 1/3 GN**  
**H max. 6,5 cm**

**EXCLUSIVE**



P90814



P908142



**GN containers not included**  
*No incluye cubetas GN*  
 Bacs GN non inclus

REF	W x D x H mm		€/u
P908142	710 x 335 x 155	1/1	201,65
P90814	710 x 335 x 155	1/1	147,10

# 14.6 Chafers & dispensers

Chafings y dispensadores / Chafers et distributeurs



- High-quality finish, large glass window and stainless steel in a shiny polished finish.
- Removable lid for easy cleaning.
- Anti-noise plastic stopper to close the lid silently.
- Hydraulic hinge.
- Diffuser base for optimal heat distribution and suitable for induction.
- Suitable for electric components P950000, 46110, and induction plate P157954.
- Acabados de alta calidad, amplia ventana de cristal y acero inoxidable en acabado pulido brillante.
- Tapa extraíble para fácil limpieza.
- Tapa de plástico antiruido para cerrar la tapa silenciosamente.
- Bisagra hidráulica.
- Fondo difusor para una óptima distribución del calor y apto para inducción.
- Compatible con los elementos eléctricos P950000 y 46110 y la placa de inducción P157954.
- Finissage de haute qualité, grande fenêtre en verre et acier inoxydable finissage brillant.
- Couvercle amovible pour un nettoyage facile.
- Butée plastique anti-bruit pour fermer le couvercle en silence.
- Charnière hydraulique.
- Fond diffuseur pour une répartition optimale de la chaleur et adapté à l'induction.
- Compatible avec les éléments électriques P950000, 46110 et la plaque à induction P157954.

## Induction warmer for chafing dish

Inducción mantenedora para chafing dish

Plaque induction maintien temp. pour chafing dish



Suitable for  
Compatible con  
Compatible avec:  
P390004, P390005, P390006

Power control  
Con control de potencia  
Contrôle de puissance

REF	Ø cm	V	W	Hz	🔊	🛒	📦	€/u
P157954	24	220-240	1000	50/60	EU	1/1		99,00

## See products on

Ver productos en / Voir produits en page

P. 495

## Electric heating unit for chafing dish

Elemento eléctrico para chafing dish

Corps de chauffe pour chafing dish



# Chafers & dispensers 14.6

Chafings y dispensadores / Chafers et distributeurs



## Round glass-top chafing dish

Chafing dish redondo con tapa de cristal

Chafing rond couvercle en verre



## Stainless steel pan included

Cubeta de acero inoxidable incluida

Bac acier inoxydable inclus

REF	W x D x H cm	L	🛒	📦	€/u
P390001	46 x 56 x 16	6	1/1		708,90

## Round stainless steel pan

Cubeta redonda en acero inoxidable

Bac rond en acier inoxydable



Suitable for  
Combinable con  
Adaptable pour  
P390001



REF	Ø cm	H cm	🛒	📦	€/u
P390007	38,5	6,5	1/10		37,70

## Round chafing stand

Stand chafing dish redondo

Support chafing rond



Suitable for  
Combinable con  
Adaptable pour  
P390001



Stackable  
Apilable  
Empilable

## 1 burner holder included

Contenedor para combustible incluido  
Porte-brûleur inclus

## Strong and robust stainless steel structure.

Resistente y robusta estructura en acero inoxidable.  
Structure en acier inoxydable résistante et robuste.

REF	W x D x H cm	🛒	📦	€/u
P390004	44,5 x 52 x 23,5	1/1		240,20

## Round porcelain pan

Cubeta redonda de porcelana

Bac rond en porcelaine



Suitable for  
Combinable con  
Adaptable pour  
P390001



REF	Ø cm	H cm	🛒	📦	€/u
P390010	38,5	6,5	1/1		71,35

# 14.6 Chafers & dispensers

Chafings y dispensadores / Chafers et distributeurs



**Square glass-top chafing dish**  
Chafing dish cuadrado con tapa de cristal  
Chafer carré couvercle en verre



**Stainless steel pan included**  
Cubeta de acero inoxidable incluida  
Bac acier inoxydable inclus

REF	W x D x H cm	L		€ / u
P390002	41 x 50 x 16	5,5	1/1	708,90

**Square chafing stand**  
Stand chafing dish cuadrado  
Support chafer carré



**Suitable for**  
Combinable con  
Adaptable pour  
P390002

**Stackable**  
Apilable  
Empilable

**1 burner holder included**  
Contenedor para combustible incluido  
Porte-brûleur inclus

**Strong and robust stainless steel structure.**  
Resistente y robusta estructura en acero inoxidable.  
Structure en acier inoxydable résistante et robuste.



REF	W x D x H cm		€ / u
P390005	48 x 37,5 x 23,5	1/1	240,20

**Rectangular glass-top chafing dish**  
Chafing dish rectangular con tapa de cristal  
Chafer rectangulaire couvercle en verre

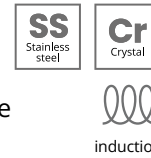

1/1



**Stainless steel pan included**  
Cubeta de acero inoxidable incluida  
Bac acier inoxydable inclus

REF	W x D x H cm	L		€ / u
P390003	58 x 50 x 16	9	1/1	759,90

**Rectangular chafing stand**  
Stand chafing dish rectangular  
Support chafer rectangulaire



**Suitable for**  
Combinable con  
Adaptable pour  
P390003

**Stackable**  
Apilable  
Empilable

**2 burner holder included**  
Contenedor para combustible incluido  
Porte-brûleur inclus

**Strong and robust stainless steel structure.**  
Resistente y robusta estructura en acero inoxidable.  
Structure en acier inoxydable résistante et robuste.

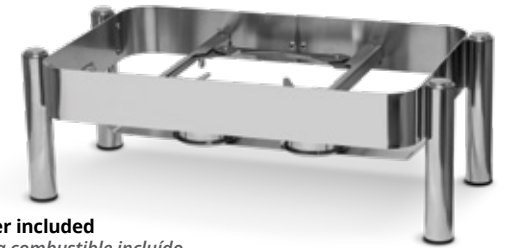

REF	W x D x H cm		€ / u
P390006	66 x 37,5 x 23,5	1/1	257,35

**Square stainless steel pan**  
Cubeta cuadrada en acero inoxidable  
Bac carré en acier inoxydable



**Suitable for**  
Combinable con  
Adaptable pour  
P390002

REF	W x D x H cm		€ / u
P390008	35,3 x 32,5 x 6,5	1/10	26,95

**Square porcelain pan**  
Cubeta cuadrada de porcelana  
Bac carré en porcelaine



**Suitable for**  
Combinable con  
Adaptable pour  
P390002

REF	W x D x H cm		€ / u
P390011	35,5 x 33 x 6,5	1/1	71,35

**Rectangular stainless steel pan**  
Cubeta rectangular en acero inoxidable  
Bac rectangulaire en acier inoxydable



**Suitable for**  
Combinable con  
Adaptable pour  
P390003

REF	W x D x H cm		€ / u
P390009	53,5 x 32,5 x 6,5	1/10	28,00

**Rectangular porcelain pan**  
Cubeta rectangular de porcelana  
Bac rectangulaire en porcelaine



**Suitable for**  
Combinable con  
Adaptable pour  
P390003

REF	W x D x H cm		€ / u
P390012	53,5 x 32,5 x 6,5	1/1	91,75

## 14.6 Chafers & dispensers

Chafings y dispensadores / Chafers et distributeurs



### Square chafing dish

Chafing dish cuadrado  
Chauffe-plat carré



REF	W x D x H cm	L		€/u
46132	39,2 x 41,3 x 20,3	5,8	1/1	1.477,00

### Glass top S/S chafer with S/S trim

Chafing dish cuadrado con tapa cristal  
Chafer inox à couvercle en verre



REF	W x D x H cm	L		€/u
46134	39,2 x 41,3 x 17,6	5,8	1/1	1.604,90

### Glass top S/S chafer with S/S trim

Chafing dish redondo con tapa cristal  
Chafer inox à couvercle en verre



REF	Ø cm	H cm	L		€/u
46125	39,4	8	5,8	1/1	1.220,00

### Food pan

Fuente interior redonda  
Bac à aliments



46131



46861  
2 compart.

REF	cm	L		€/u
46131	39,4 x 7	5,6	1/1	217,55
46861	39,4 x 7	3,8	1/1	121,80

### Food pan

Fuente interior cuadrada  
Bac à aliments



46137

REF	W x D x H cm	L		€/u
46137	39,2 x 7,1 x 39,2	6,3	1/1	270,55

## Chafers & dispensers 14.6

Chafings y dispensadores / Chafers et distributeurs



### Rectangular chafing dish roll top lid

Chafing dish rectangular con tapa roll top  
Chafing dish rectangulaire avec couvercle roll top



Stand, water pan, insert, lid and St/Steel handles. With 2 burners.

Soporte, recipiente, cubeta, tapa y asas de chapa en acero inox. Con 2 quemadores.

Support, récipient, bac, couvercle et poignées en acier inox. Avec 2 brûleurs.

REF	W x D x H cm	L		€/u
P387500	74 x 45 x 41	9	1/1	431,60

### Round chafing dish roll top lid

Chafing dish redondo tapa roll top  
Chafing dish rond avec couvercle roll top

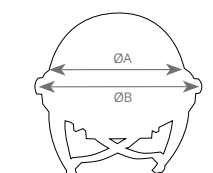

Max. opening: 180°.  
Apertura máxima: 180°.  
Ouverture maximale: 180°.

REF	ØA cm	ØB cm	H cm	L		€/u
P897500	35	51,5	48,5	6	1/1	385,45

# 14.6 Chafers & dispensers

Chafings y dispensadores / Chafers et distributeurs



**Chafing dish with roll top lid**  
Chafing dish con tapa roll top  
Chafing dish avec couvercle "roll top"



**Stand, water pan, insert, lid and St/Steel handles. With 2 burners.**  
Soporte, recipiente, cubeta, tapa y asas de chapa en acero inox. Con 2 quemadores.  
Support, récipient, bac, couvercle et poignées en acier inox. Avec 2 brûleurs.

REF	W x D x H cm	L	🛒/📦	€/u
P387065	65 x 38 x 39	9,5	1/1	324,05

**Chafing dish with lid**  
Chafing dish con tapa  
Chafing dish avec couvercle



**Stand, water pan, insert, lid and St/Steel handles. With 2 burners.**  
Soporte, recipiente, cubeta, tapa y asas de chapa en acero inox. Con 2 quemadores.  
Support, récipient, bac, couvercle et poignées en acier inox. Avec 2 brûleurs.

REF	W x D x H cm	L	🛒/📦	€/u
P379065	65 x 35 x 34	9,5	1/1	255,95

**Economical chafing dish with lid**  
Chafing dish económico con tapa  
Chafing dish économique avec couvercle



**Stand, water pan, insert, lid and St/Steel handles. With 2 burners.**  
Soporte, recipiente, cubeta, tapa y asas de chapa en acero inox. Con 2 quemadores.  
Support, récipient, bac, couvercle et poignées en acier inox. Avec 2 brûleurs.

REF	W x D x H cm	L	🛒/📦	€/u
P379500	65 x 35 x 32	9	1/1	131,55

**Bain maries**  
Baño maría  
Bain-marie



REF	Ø cm	H cm	L	🛒/📦	€/u
78710	10,5	14,5	1,20	1/6	33,05
78720	12,5	17,0	1,90	1/6	42,15
78725	15,5	10,0	1,90	1/6	42,15
78730	15,5	18,5	3,30	1/6	45,25
78740	16,5	19,5	4,00	1/6	49,65
78760	18,5	22,0	5,70	1/6	62,55

**Cooling plate**  
Placa enfriadora  
Plaque réfrigérante



**For an easy and hygienic presentation of cold food. Simple place in the freezer. Minimum 4 hour under -4°C. Tolerance under 23°C: 5-6h.**

Para una presentación fácil e higiénica de alimentos fríos en los buffets. En el congelador: Mínimo 4h por debajo de los -4 °C. Aguanta 5-6h con temperaturas por debajo de los 23 °C.

Pour une présentation hygiénique et facile des aliments froids sur les buffets. Au congélateur. Minimum 4h à des températures inférieures à -4 °C. Résistance à des températures inférieures à 23 °C: 5-6h.

REF	Type / Tipo	cm	🛒/📦	€/u
P903001	1/1	53 x 32,5	1/1	213,70
P903002	1/2	32,5 x 26,5	1/1	146,90

**Electric heating unit for chafing dish**  
Elemento eléctrico para chafing dish  
Corps de chauffe pour chafing dish



Suitable for stands / Compatible con stands / Compatible avec stands : P387500, P897500, P387065, P379065, P379500, P390004, P390005, P390006

REF	W	🛒/📦	€/u
P950000	240	1/1	224,50

**Hot tray warmer**  
Calentador de platos o bandejas  
Réchaud



**Burner holder for chafing dish**  
Contenedor para combustible de chafing dish  
Porte-brûleur pour chafing dish



Adaptable. REF: P379, P387

REF	🛒/📦	€/u
P372200	1/1	10,45

**Chafing dish fuel**  
Fuel para chafing dish  
Fuel pour chafing dish



REF	cm	g	Lenght / Duración	🛒/📦	€/u
P387100	6,5 x 5,5	160	3 h	1/75	2,60
P387200	8,3 x 6,0	280	6 h	1/60	4,85

**Universal electric chafers heater**  
Elemento eléctrico universal para chafing dish  
Résistance électrique pour chafers



Sized to fit standard fuel opening.  
Dimensiones compatibles con el orificio para combustible estándar.  
Dimensions compatibles avec l'orifice pour combustible standard.

REF	For / Para	V	W	A	Ench. Plug	🛒/📦	€/u
46110	EU	230	120/230	1.0	EU	1/1	456,70
46115	UK	230	120/230	1.0	UK	1/1	456,70

REF	Burners Quemadores Brûleurs	W x D x H cm	🛒/📦	€/u
P962002	2	37 x 17,5 x 7	1/1	62,20
P962003	3	43 x 17,5 x 7	1/1	94,35

St/Steel with aluminium cover plate. 2 or 3 burners.  
Inox con placa base de aluminio. 2 ó 3 quemadores.  
Inox avec plaque couvercle en aluminium. 2 ou 3 brûleurs.

**Chafing dish fuel barrel**  
Fuel para chafing dish  
Bidón fuel chafing dish



No soot. No smell  
Sin hollín. Sin olor  
Pas de suie. Inodore

REF	L	Kg	🛒/📦	€/u
P685004	5	5	1/1	39,45

Thanks to its special formula no storage or transport restriction are involved. Resealable. Non spill - Non drip. Non flammable. Non combustible. Non toxic fuel. Easy open & close. Container does not become hot to touch. Does not evaporate if left uncapped.

Gracias a su fórmula especial no hay ninguna restricción especial por almacenaje o transporte. No gotea ni se derrama. No se evapora si se deja abierto. Puede guardarse si no se consume todo. No inflamable. No tóxico. Fácil de abrir y cerrar. La lata no se calienta. Fácil de encender una vez apagada.

Grâce à sa formule spéciale il n'y pas de restriction pour le stockage et le transport. Hermétique. Non inflammable. Non combustible. Non toxique. Facile à ouvrir et fermer. On peut le garder si on ne le consomme pas tout. Facile à allumer une fois éteint.

# 14.6 Chafers & dispensers

Chafings y dispensadores / Chafers et distributeurs

**Cold beverage server**  
 Dispensador de bebidas frías  
 Distributeur boisson froide



REF	W x D x H cm	L		€/u
46285	20,3 x 28 x 53,3	7,6	1/1	934,05

**Somerville milk dispenser**  
 Dispensador de leche-Somerville  
 Distributeur de lait Somerville



REF	W x D x H cm	L		€/u
4635110	20,3 x 32,7 x 41,4	4,8	1/1	1.451,50

**Cereal dispenser**  
 Dispensador de cereales  
 Distributeur à céréales



REF	W x D x H cm	L		€/u
P899400	20 x 24 x 64	3,5	1/1	101,95

**Double cereal dispenser**  
 Dispensador de cereales doble  
 Distributeur à céréales double



REF	W x D x H cm	L (x2)		€/u
P899500	33,5 x 24 x 64	3,5	1/1	173,35

**Juice dispenser St/Steel**  
 Dispensador de zumos - acero inox  
 Distributeur à jus - acier inox



REF	W x D x H cm	L		€/u
P899200	26 x 35 x 57	8	1/1	249,05

**St/Steel milk dispenser**  
 Dispensador de leche - acero inox  
 Distributeur à lait - acier inox



REF	W x D x H cm	L		€/u
P899300	26 x 35 x 57	8	1/1	271,70

**Cereal dispenser**  
 Dispensador de cereales  
 Distributeur à céréales



REF	W x D x H cm	L		€/u
P899600	21 x 17 x 61,5	3,5	1/1	96,85

**Double Cereal Dispenser**  
 Dispensador de cereales doble  
 Distributeur à céréales double



REF	W x D x H cm	L (x2)		€/u
4635210	31 x 22 x 60	3,8	1/1	1.041,35

# 14.7 Protection and covers

Protección y tapas / Protection et couvercles

**Mobile and ajustable breath guards**  
*Protección Anti-aliento regulable*  
 Pare-haleine ajustable



**Adjustable in tilt and height to adapt to different spaces. Protect exposed foods without losing visibility.**

*Ajustable en inclinación y altura para adaptarse a diferentes espacios. Protege los alimentos expuestos sin perder visibilidad.*

*Hauteur et inclinaison réglables pour s'adapter à tous les espaces des buffets. Protège et laisse visible les aliments exposés.*

REF	W x D x H cm	🛒/📦	€/u
P19120	120 x 45 x 38	1/1	593,00

**Dome cover**  
*Tapa campana*  
 Couvercle cloche



REF	Ø cm	H cm	🛒/📦	€/u
P590008	21	17,5	1/1	32,55
P590009	26	20,0	1/1	38,00
P590010	31	23,5	1/1	43,35

**Display tray**  
*Bandeja presentación*  
 Plateau présentation

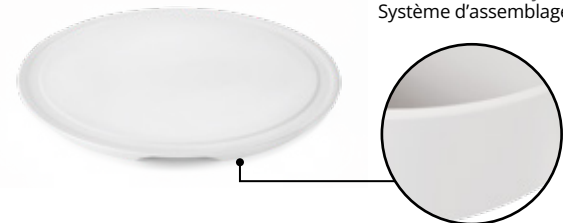

**Fitting system**  
*Sistema de encaje*  
 Système d'assemblage

REF	Ø cm	H cm	🛒/📦	€/u
P22361	22,7	1,5	1/12	8,50
P22362	27,8	1,5	1/6	10,80
P22363	32,7	1,5	1/6	15,20

**Stand**  
*Stan*  
 Base



**Suitable for**  
*Combinable con*  
 Adaptable pour  
 P22361 / P22362 / P22363

REF	Ø cm	H cm	🛒/📦	€/u
P22366	16,5	10	1/6	10,95
P22367	16,5	18	1/6	16,30

**Clear round lid for presentation**  
*Tapa redonda transparente presentación*  
 Couvercle rond transparent pour présentation



REF	Ø cm	H cm	Suitable for <i>Combinable con</i> <i>Adaptable pour</i>	🛒/📦	€/u
P598700	22	13,5	P22127 / P22124	1/1	17,50
P598800	27	16,5	P22128 / P22125	1/1	21,95

# Protection and covers 14.7

Protección y tapas / Protection et couvercles

**Round display cabinet**  
*Vitrina redonda*  
 Vitrine ronde



REF	Ø cm	H cm	Base útil <i>Functional basic</i> Base utile Ø cm	🛒/📦	€/u
P590005	38	22	31,5	1/1	39,90
P590006	46	26	37,5	1/1	56,20

**Rectangular display cabinet**  
*Vitrina rectangular*  
 Vitrine rectangulaire



REF	W x D x H cm	Base útil <i>Functional basic</i> Base utile Ø cm	🛒/📦	€/u
P590001	40 x 24,5 x 15,5	34 x 19	1/1	51,55
P590002	50,5 x 30,5 x 18	44 x 24,5	1/1	58,75

**Double display cabinet**  
*Vitrina doble*  
 Vitrine double



REF	W x D x H cm	Base útil <i>Functional basic</i> Base utile Ø cm	🛒/📦	€/u
P590003	40 x 24,5 x 32	2 x (34 x 19)	1/1	92,70
P590004	50,5 x 30,5 x 40	2 x (44 x 24,5)	1/1	117,35

**Clear GN lids for presentation**  
*Tapas GN transparentes presentación*  
 Couvercles GN transparents de présentation



REF	Mod	H cm	🛒/📦	€/u
P590110	1/1	10	1/6	50,05
P590120	1/2	10	1/6	28,40
P590130	1/3	10	1/6	26,15
P590240	2/4	10	1/12	29,65

**Roll-top lid**  
*Tapa roll-top*  
 Couvercle roll-top



REF	Mod	W x D x H cm	🛒/📦	€/u
P904300	1/1	57 x 32,5 x 17,5	1/1	78,30

**GN prectangular lid**  
*Tapa rectangular GN*  
 Couvercle rectangulaire GN



REF	Mod	W x D x H cm	🛒/📦	€/u
P834000	1/1	53 x 32,5 x 10	1/6	90,65

# 14.8 Bowls & serving trays

Bols & bandejas de servicio / Bols & plateaux

18/10  
Stainless steel

**Double wall insulated serving bowls that allows keeping the food temperature, whether cold or hot.**

Construcción aislante de pared doble que permite conservar la temperatura de los alimentos, ya sean fríos o calientes.

Construction d'isolation à double paroi qui permet de maintenir la température de la nourriture, froide ou chaude.

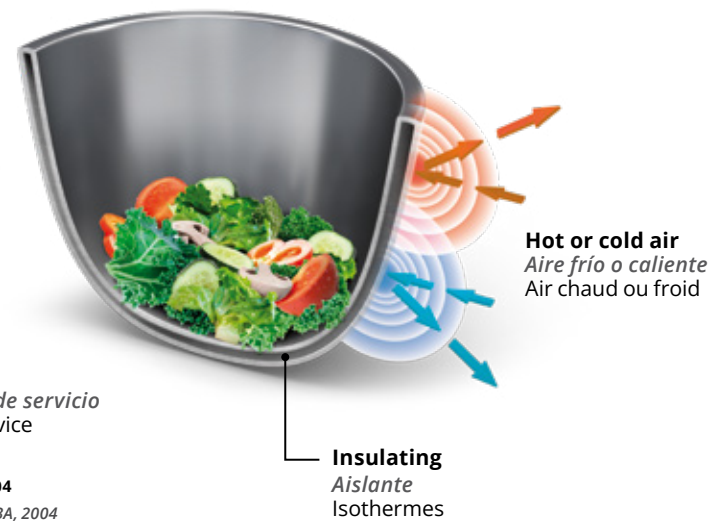

**Will not TRANSPIRE. Requires no preheating or chilling**

No transpiran. No es necesario precalentar o enfriar  
Pas de condensation sur les parois. N'exige aucun préchauffage ou refroidissement

**Insulating walls that keep food at service temperature**

Paredes aislantes que mantienen los alimentos a la temperatura de servicio  
Construction isolant qui garde les aliments à la température de service

**COLD RETENTION: Double wall insulated bowls TEST PROTOCOL, 2004**

RETENCIÓN DEL FRÍO: Bols aislantes de doble pared PROTOCOLO DE PRUEBA, 2004

RÉTENTION DU FROIDE: Construction d'isolation à double paroi PROTOCOLE D'ESSAI, 2004

**Angled beehive bowls**

Bol inclinado doble pared

Bols nid d'abeilles à paroi inclinée

NSF



REF	Ø cm	H cm	L	🛒/📦	€/u
46584	18,8	13,9	0,95	1/6	56,40
46585	24,0	17,3	1,7	1/6	88,85
46586	30,0	20,9	3,5	1/2	129,50
46582	35,0	23,9	4,7	1/2	198,85

**Double-wall square beehive serving bowls**

Bol estriado cuadrado doble pared

Bol lis carré double paroi

NSF



REF	W x D x H cm	L	🛒/📦	€/u
47619	13,9 x 13,9 x 7	0,7	1/6	48,70
47632	18,5 x 18,5 x 8,9	1,7	1/12	61,25
47634	21,8 x 21,8 x 10,8	3,0	1/6	83,65
47635	24,4 x 24,4 x 13,1	4,9	1/4	112,70
47637	29,9 x 29,9 x 15	7,8	1/3	150,65

**Beehive style double-wall serving bowls**

Bol estriado redondo doble pared

Bol à bande rond double paroi

NSF

**Mirror finished**  
Acero inoxidable brillante  
Polissage brillant



REF	Ø cm	H cm	L	🛒/📦	€/u
46587	14,4	7,6	0,7	1/6	39,90
46590	18,4	10,3	1,6	1/6	60,50
46591	24,1	12,9	3,2	1/6	95,75
46592	30,0	16,5	6,6	1/3	140,50
46569	35,0	17,5	9,6	1/2	200,00

**Beehive style double-wall serving bowls**

Bol redondo doble pared con aro brillante

Bol bande brillant rond double paroi

NSF

**Body mat finished.**  
**Rim mirror finished.**  
Cuerpo pulido satinado.  
Borde superior pulido brillante.  
Finition corps satinée.  
Finition bande brillante.



REF	Ø cm	H cm	L	🛒/📦	€/u
46665	14,4	7,6	0,7	1/6	39,90
46666	18,4	10,3	1,6	1/6	50,95
46667	24,1	12,9	3,2	1/6	80,45

# Bowls & serving trays 14.8

Bols & bandejas de servicio / Bols & plateaux

**Satin-finished rim and mirror-finished interior creates a visual contrast that accentuates the food product**

Borde con acabado satinado e interior brillante, creando una elegante contraste visual

Le rebord satiné et l'intérieur ultra-brillant crée un contraste visuel qui met en valeur les plats

**Rectangular Stainless Steel serving trays**  
Bandeja servicio rectangular acero inoxidable  
Plateau service rectangulaire

18/10  
Stainless steel



REF	cm	🛒/📦	€/u
82093	30,5 x 22,9	1/3	52,35
82094	45,7 x 25,4	1/3	76,85
82095	53,3 x 30,5	1/3	101,30

**Economical oval serving dish with rolled edge**

Fuente oval borde vuelto económica  
Plat ovale à bords ronds économique

18/10  
Stainless steel

**Mirror finished**  
Pulido brillante  
Polissage brillant



REF	cm	🛒/📦	€/u
P317425	25 x 17,5	1/10	8,10
P317430	30 x 21,0	1/10	9,15
P317435	35 x 24,0	1/10	10,85
P317440	40 x 26,5	1/10	11,95
P317445	45 x 29,5	1/10	14,55
P317450	50 x 34,0	1/10	18,55

**Oval serving dish with rolled edge**

Fuente oval borde vuelto  
Plat ovale à bords ronds

18/10  
Stainless steel

**Satin finished**  
Pulido satinado  
Polissage satiné



REF	cm	🛒/📦	€/u
P317025	25 x 17,2	1/50	11,25
P317030	30 x 20,2	1/50	13,70
P317035	35 x 23,3	1/25	16,65
P317040	40 x 26,7	1/25	20,65
P317045	45 x 29,2	1/25	23,15
P317050	50 x 31,2	1/25	30,05

**St/Steel soup tureen with stand**

Sopera inox con base  
Soupière inox avec pied

SS  
Stainless steel



**Mirror finished**  
Pulido brillante  
Polissage brillant

REF	Ø cm	L	🛒/📦	€/u
P907024	24	2,50	1/3	19,30
P907026	26	3,50	1/3	22,00

**Acrylic Squared salad bowl**

Ensaladera acrílica cuadrada  
Saladier carré acrylique

Ac  
Acrylic



REF	W x D x H cm	🛒/📦	€/u
P928000	28,5 x 28,5 x 12,4	1/12	17,80
P928001	14,7 x 14,7 x 7	1/48	3,85



# Serving tools 14.9

Utensilios de servicio / Ustensiles de service buffet



## CLASSIC LINE



**One piece ladle**  
Cacillo monobloc  
Louche monobloc



REF	Ø cm	L cm	L	€/u
P361000	9	30	0,10 1/12	15,45

**One piece skimmer**  
Espumadera monobloc  
Écumoire monobloc



REF	Ø cm	L cm	L	€/u
P362000	11	33,5	10,40 1/12	14,55

**One piece turner**  
Espátula monobloc  
Spatule monobloc



REF	L cm	€/u
P363000	32	12,95

**One piece serving spoon**  
Cuchara de servicio monobloc  
Cuillère de service monobloc



REF	L cm	€/u
P364000	31	11,65

**One piece fork**  
Tenedor monobloc  
Fourchette monobloc



REF	L cm	€/u
P365000	32	10,45

**One piece sauce ladle**  
Cacillo salsas monobloc  
Cuillère à sauces monobloc



REF	Ø cm	L cm	L	€/u
P366000	7	28	0,10 1/12	13,85

**One piece salad spoon**  
Cuchara ensalada monobloc  
Cuillère à salade monobloc

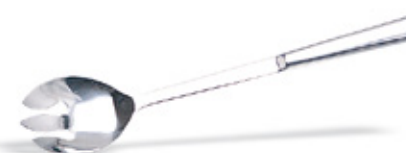

REF	L cm	€/u
P367000	30	11,70

**Carving knife**  
Cuchillo cocina  
Couteau à pâtisserie



REF	L cm	€/u
P368000	28,5	8,85

**Cake server**  
Pala pasteles  
Pelle à gâteau



REF	L cm	€/u
P369000	22	9,50

# 14.9 Serving tools

Utensilios de servicio / Ustensiles de service buffet



## ERGO LINE



**Mirror polishing.**  
Pulido brillante.  
Polissage brillant.

**One piece ladle**  
Cacillo monobloc  
Louche monobloc



REF	Ø cm	L cm	L		€/u
P361100	9,5	32	0,15	1/6	11,10

**One piece skimmer**  
Espumadera monobloc  
Écumoire monobloc



REF	Ø cm	L cm	L		€/u
P362100	11	35	7,15	1/6	10,05

**One piece turner**  
Espátula monobloc  
Spatule monobloc



REF	L cm		€/u
P363100	37	1/6	9,50

**One piece serving spoon**  
Cuchara de servicio monobloc  
Cuillère de service monobloc



REF	L cm		€/u
P364100	34,5	1/6	8,50

**Spaghetti server**  
Cuchara para spaghetti  
Cuillère à spaghetti



REF	L cm		€/u
P367100	35	1/6	8,50

**Cake server**  
Pala pasteles  
Pelle à gâteau



REF	L cm		€/u
P369100	31	1/6	7,60

# Serving tools 14.9

Utensilios de servicio / Ustensiles de service buffet



## COMET LINE



**Mat satiny finished.**  
Pulido satinado mate.  
Poli satiné mat.

**One piece ladle. 18% cr. St/Steel**  
Cacillo monobloc. Acero inox 18% cr.  
Louche monobloc. inox 18% cr.



REF	Ø cm	L cm	L		€/u
P341000	8,5	28	0,10	1/10	8,85

**One piece skimmer. 18% cr. St/Steel**  
Espumadera monobloc. inox 18% cr.  
Écumoire monobloc. inox 18% cr.



REF	Ø cm	L cm		€/u
P342000	11	33	1/12	8,75

**One piece turner. 18% cr. St/Steel**  
Espátula monobloc. inox 18% cr.  
Spatule monobloc. inox 18% cr.



REF	L cm		€/u
P343000	33	1/10	6,85

**One piece spoon. 18% cr. St/Steel**  
Cuchara monobloc. inox 18% cr.  
Cuillère monobloc. inox 18% cr.



REF	L cm		€/u
P345000	34	1/10	6,95

**Steak knife black plastic handle**  
Cuchillo chuletero, mango plástico negro  
Couteau Steak manche noir plastique



REF	Blade / Hoja / Lame L cm	Total L cm		€/pack 12 u
48144	12,4	25,1	1/12	54,15

Price / Precio / Prix: Pack 12 u

# 14.9 Serving tools

Utensilios de servicio / Ustensiles de service buffet



**Ladle with one spout**  
Cacillo con un pico lateral  
Louche avec bec latéral

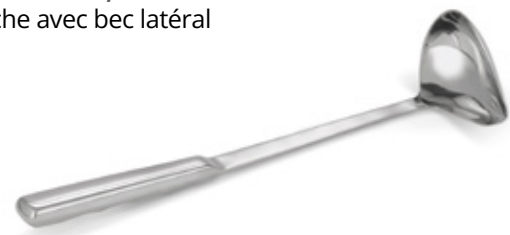

REF	L cm		€ / u
46905	28,71	1/12	15,60

**Ladle with one spout**  
Cacillo con un pico lateral  
Louche avec bec latéral



REF	L cm	ml		€ / u
46907	32	59,15	1/12	19,30

**Ladle**  
Cacillo  
Louche



REF	L cm		€ / u
46909	32	1/12	20,95

**Pastry server**  
Servidor de pasteles  
Pelle de service



REF	L cm		€ / u
46936	28	1/12	11,30

**Serving spoon**  
Cuchara de servicio  
Cuillère de service



REF	L cm		€ / u
46952	29,5	1/12	13,65

**Slotted serving spoon**  
Cuchara perforada para servir  
Cuillère à fente de service



REF	L cm		€ / u
46960	30,5	1/12	14,75

**Spoon**  
Cuchara  
Cullière



REF	L cm		€ / u
64403	33,60	1/12	16,50
64404	33,60	1/12	16,50
64406	39,37	1/12	20,10
64407	39,37	1/12	20,10

# Serving tools 14.9

Utensilios de servicio / Ustensiles de service buffet



dishwasher

- 40 °C

+210 °C

**Ladle**  
Cacillo  
Louche



REF	L cm	Lts		€ / u
P33621	35	0,08	1/12	8,15

**Serving spoon**  
Cuchara de servicio  
Cuillère de service



REF	L cm		€ / u
P33622	35	1/12	8,15

**Slotted spoon**  
Cuchara perforada  
Cuillère à fente



REF	L cm		€ / u
P33623	35	1/12	8,15

**Turner**  
Espátula  
Patule



REF	L cm		€ / u
P33624	35	1/12	8,15

**Spaghetti server**  
Cuchara para spaghetti  
Cuillère à spaghetti



REF	L cm		€ / u
P33625	35	1/12	8,15

# 14.9 Serving tools

Utensilios de servicio / Ustensiles de service buffet



**Serving spoon**  
Cuchara de servicio  
Cuillère de service



REF	L cm		€/ u
P33801	30,5	1/16	5,40

**Turner**  
Espátula  
Spatule



REF	L cm		€/ u
P33803	30,5	1/10	5,40

**Serving tong**  
Pinza de servicio  
Pince de service



REF	L cm		€/ u
P33806	28	1/10	7,50

**Bread spoon**  
Pinza de pan  
Pince à pain



REF	L cm		€/ u
P33807	25,5	1/8	7,50

See products on / Ver productos en / Voir produits en page

P. 449

**Wooden bowl**  
Bol de madera  
Bol en bois



# Serving tools 14.9

Utensilios de servicio / Ustensiles de service buffet



**Coloured BPA Free utility tong**  
Pinza buffet BPA Free color  
Pince buffet SANS BPA en couleurs



REF	L cm	Clear Transp.	○	●	●		€/ u
P358	23	0	1	2	7	1/12	4,35

REF 358 + L + COLOR

**Serving tong**  
Pinza servicio  
Pince de service



REF	L cm		€/ u
46926	21	1/12	14,30

**Buffet tong**  
Pinza buffet  
Pince à buffet



REF	L cm		€/ u
46938	30,5	1/6	17,10

**Spaghetti tong**  
Pinza espagueti  
Pince à spaghettis



REF	L cm		€/ u
46988	23,0	1/12	21,60
46989	29,2	1/12	31,40

# 14.9 Serving tools

Utensilios de servicio / Ustensiles de service buffet



**Serving tong**  
Pinza de servicio  
Pince de service



REF	L cm		€ / u
P359000	24	1/12	10,05

**Salad tong**  
Pinza ensalada  
Pince à salade



REF	L cm		€ / u
P353000	26,5	1/12	21,55

**Bread tong**  
Pinza pan  
Pince à pain



REF	L cm		€ / u
46928	23,5	1/12	16,90

**Bread tong**  
Pinza pan  
Pince à pain



REF	L cm		€ / u
P606000	25	1/12	23,15

**Pasta tong**  
Pinza pasta  
Pince à pâtes



REF	L cm		€ / u
P605000	24	1/12	6,25

**Spaghetti tong**  
Pinza spaghetti  
Pince à spaghetti



REF	L cm		€ / u
P351000	19	1/12	4,50

**Cake tong**  
Pinza repostería  
Pince à gâteau



REF	L cm		€ / u
P352000	18	1/12	11,70



**Tong with ring**  
Pinza anillas  
Tong with ring



REF	L cm		€ / u
P617017	17	1/12	7,25

**Pastry tong**  
Pinza pastelería  
Pince à pâtisserie



REF	L cm		€ / u
46929	20	1/24	9,95

**Butcher's tong**  
Pinza charcutería  
Pince à charcuterie



REF	L cm		€ / u
P902000	10,5 x 5	1/12	8,45

# Serving tools 14.9

Utensilios de servicio / Ustensiles de service buffet

**Burger tong**  
Pinza hamburguesa  
Pince à "burger"



REF	L cm		€ / u
P618000	24	1/12	13,85

**Nut cracker**  
Cascanueces  
Casse-noix



REF	L cm		€ / u
P615000	16,5	1/12	8,95

**Aluminium lobster cracker**  
Pinza para mariscos en aluminio  
Casse-pattes en aluminium



REF	L cm		€ / u
P389000	14	1/24	5,10

BUFFET & ACCESSORIES  
BUFFET / ACCESSOIRES  
BUFFET ET ACCESSOIRES

BUFFET & ACCESSORIES  
BUFFET / ACCESSOIRES  
BUFFET ET ACCESSOIRES

# 14.10 Signs

Señalización / Signalization

**Barrier with retractable belt**  
 Poste con cinta retráctil  
 Poteau dérouleur à sangle



Pintado negro  
**Black-painted**  
 Peint noir

REF	H cm	Kg		€/u
P19117	90	7	1/6	80,85

**Barrier with retractable belt**  
 Poste con cinta retráctil  
 Poteau dérouleur à sangle



**Mirror Polished.**  
 Pulido brillante.  
 Polissage brillant.

**Detachable head.**  
 Cabezal removible.  
 Tête amovible.

REF	Ribbon / Cinta Ruban	H cm	L cm	Kg		€/u
P19114N	●	94	200	9	1/2	107,00
P19114A	●	94	200	9	1/2	107,00
P19114R	●	94	200	9	1/2	107,00

**Information sign**  
 Panel información  
 Panneau information



For barrier  
 Para poste  
 Pour poteau  
**P19117**

REF	cm		€/u
P19118	22 x 46	1/10	51,80

**Spare head**  
 Recambio cabezal  
 Rechange de sangle



For barrier  
 Para poste  
 Pour poteau  
**P19114**

REF	Ribbon / Cinta Ruban	L cm		€/u
P19115N	●	200	1/12	50,35
P19115A	●	200	1/12	50,35
P19115R	●	200	1/12	50,35

**Information sign**  
 Panel información  
 Panneau information



For barrier  
 Para poste  
 Pour poteau  
**P19114**

REF	cm		€/u
P19116	21,8 x 32	1/10	56,80

**St/Steel barrier**  
 Poste separación acero inoxidable  
 Poteau acier inoxydable



**P19100**  
**Mirror Polished.**  
 Pulido brillante.  
 Polissage brillant.

**P19101**  
**Golden coated.**  
 Baño dorado.  
 Doré.

**Belt not included**  
 Cordon no incluido  
 Cordon non inclus

REF	H cm	Kg		€/u
P19100	95	10,5	1/2	98,10
P19101	100	10,5	1/2	109,55

**Belt with chromium-plated ends**  
 Cordón con ganchos cromados  
 Cordon à crochets chromés

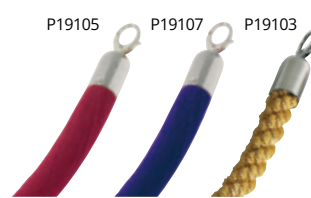

REF	Blet Cord. Ruban	L cm		€/u
P19105	●	150	1/18	24,05
P19107	●	150	1/18	24,05
P19103	●	150	1/18	48,10

**Belt with golden ends**  
 Cordón con ganchos dorados  
 Cordon à crochets dorés



REF	Blet Cord. Ruban	L cm		€/u
P19106	●	150	1/18	24,05
P19104	●	150	1/18	51,60

# Signs 14.10

Señalización / Signalization

Produced from special plastic completely anti-scratch material. Solid wood frame double-lacquered. Rain and sunproof. Writing-surfaces specially designed for using water based chalkmarkers.

Fabricadas con un material plástico especial que no se raya. Marcos de madera resistentes al agua y al sol. Pizarras especialmente diseñadas para el uso de tizas o rotuladores con base de agua.

Fabriqués avec un matériel plastique spécial anti-rayures. Cadres en bois massif. Résistants à la pluie et au soleil. Tableaux spécialement conçus pour l'utilisation des craies ou marqueurs avec base à eau.

**Caballote - Duo**



REF	W cm	H cm		€/u
P21000	75	135	1/1	235,75
P21001	55	85	1/1	154,75

**Universal**



REF	W cm	H cm		€/u
P21005	50	60	1/1	36,50

**Basic**

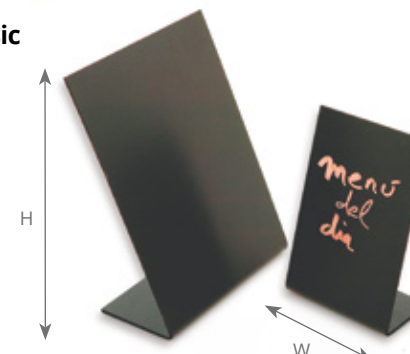

REF	W cm	H cm		€/u
P21027	10	15	1/50	7,05
P21028	15	23	1/50	11,80

**Caballote - Uno**

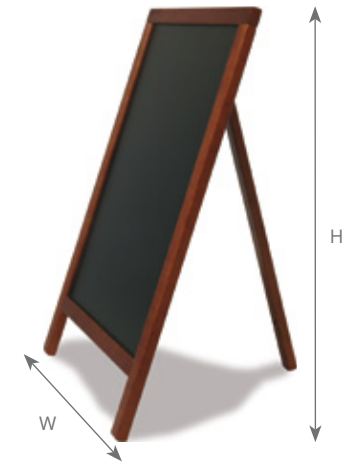

REF	W cm	H cm		€/u
P21003	55	85	1/1	83,45

**Lucky**

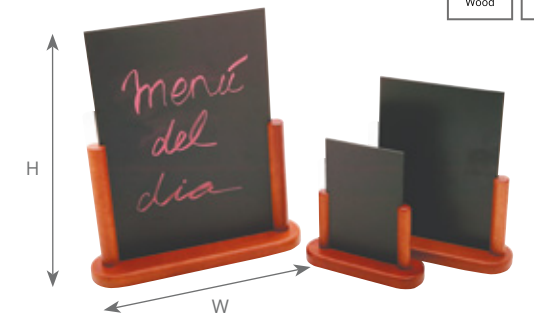

REF	W cm	H cm		€/u
P21015	10	15	1/1	10,05
P21016	15	21	1/1	11,95
P21017	21	30	1/1	19,90

**Chalkmarker**  
 Marcadore tiza  
 Marqueur

Widths 2-6 mm  
 Grueso 2-6 mm  
 Épaisseur 2-6 mm

REF	Colour / Color / Couleur		€/u
P21020	White / Blanco / Blanc	1/1	7,10